



## USER MANUAL

# COMPUTRAC<sup>®</sup> MAX<sup>®</sup> 1000 MOISTURE ANALYZER OPERATION MANUAL

July 1996  
Firmware Revision 3.03A

**ARIZONA INSTRUMENT LLC**  
3375 N Delaware Street | Chandler, AZ 85225 USA  
800.528.7411 | 602.470.1414 | f 602.281.1745

[www.azic.com](http://www.azic.com)

Email:  
General - [azi@azic.com](mailto:azi@azic.com)  
International - [intl@azic.com](mailto:intl@azic.com)  
Customer Service - [support@azic.com](mailto:support@azic.com)

ARIZONA INSTRUMENT LLC  
3375 N Delaware St | Chandler, AZ 85225  
800.528.7411 | [sales@azic.com](mailto:sales@azic.com) | [www.azic.com](http://www.azic.com)  
MADE IN THE USA

AZI P/N 700-0003-B | SS-187-B  
Last update July 1996



# **Computrac MAX-1000**

## **User's Manual**

### PROPRIETARY RIGHTS NOTICE

The material in this manual contains valuable information developed by Arizona Instrument Corporation for use with the Computrac line of moisture analyzers. No part of this manual can be reproduced or transmitted in any form or by any means, electronic, mechanical, or otherwise. This includes photocopying and recording or in connection with any information storage or retrieval system without the express written permission of Arizona Instrument Corporation.

ALL RIGHTS RESERVED

© Copyright 1996 Arizona Instrument Corporation



# **PACKING and SHIPPING INSTRUCTIONS**

---

---

The MAX-1000 uses a delicate and very sensitive electronic force balance to measure small weights and weight losses. Movement, handling, and packaging of the instrument must be done with **EXTREME CARE** to avoid permanent, expensive damage internally.

## **UNPACKING**

---

---

Unpack the instrument carefully and set it down gently. Select a place where it will be safe from bumping, jarring, and excessive vibration.

For all shipments, boxes and packing materials are available from AZI. Call AZI Customer Service at (800) 235-3360 or (602) 470-1414 for additional shipping information when returning a unit for repair.

Retain all packaging materials for any future shipment of the instrument. If the instrument is returned to Arizona Instrument for any reason, it must be placed in the original packaging materials which have been tested and proven to be effective protection during shipment.

## **REPACKING FOR SHIPMENT**

---

Remove the pan support, balance adapter, and circular balance cover from the test chamber. Wrap and package them in their own box.

Pack the MAX-1000 and the small box containing the heat shroud/pan support in a Computrac MAX-1000 shipping container, using the packing figure supplied on the box as a guide.

If proper shipping materials are not available, contact AZI Customer Service at (800) 235-3360 or (602) 470-1414 to have a set (AZI Part Number 751-0008) sent to you.

AZI WILL NOT BE RESPONSIBLE FOR SHIPPING DAMAGE.

IF YOU RETURN THE INSTRUMENT VIA ANY OTHER SHIPPER THAN FEDERAL EXPRESS, YOU SHOULD INSURE IT FOR FULL VALUE.

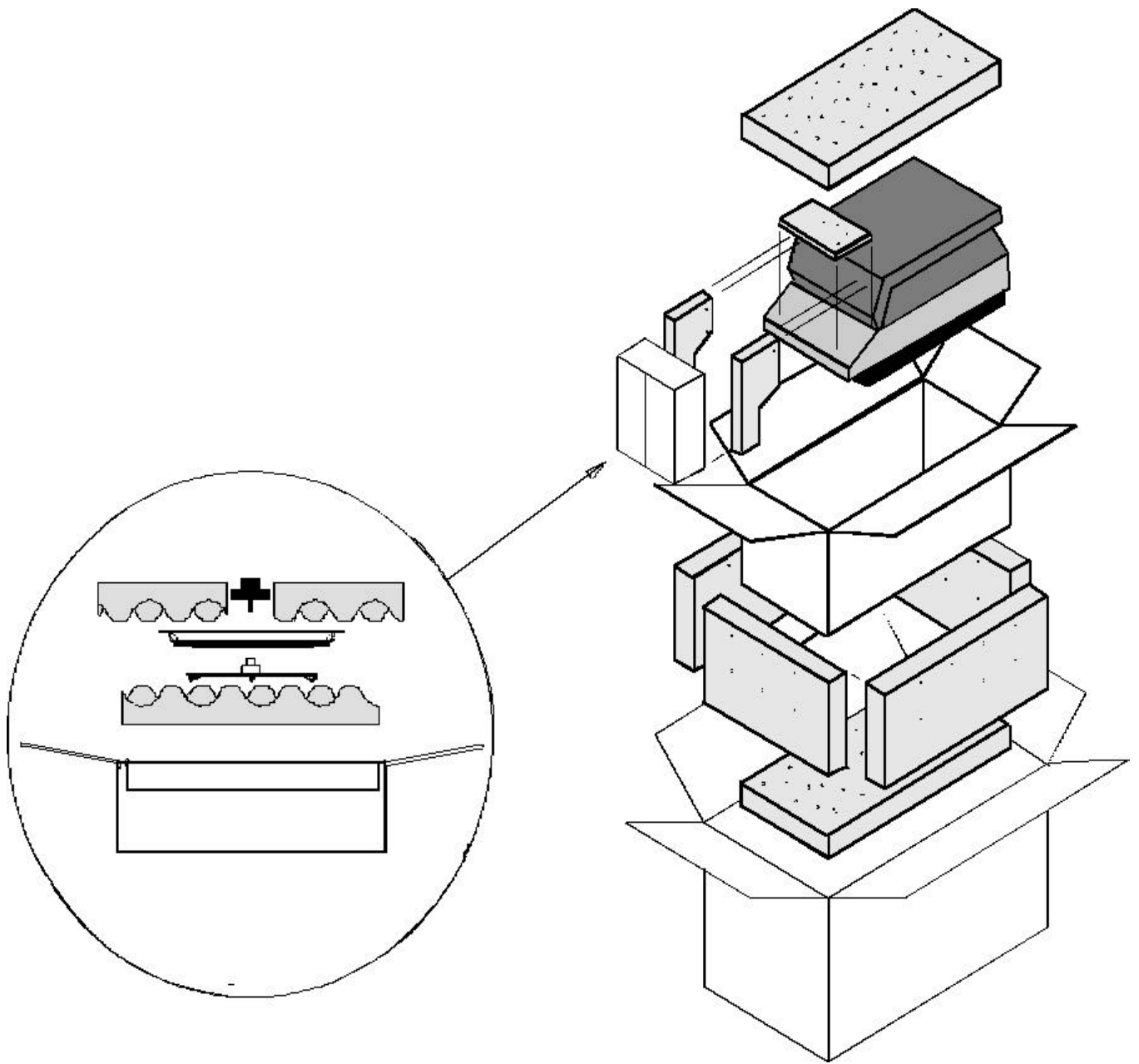

**Figure 1** MAX-1000 PACKING DIAGRAM



# TABLE of CONTENTS

PACKING and SHIPPING INSTRUCTIONS .....	v
UNPACKING .....	v
REPACKING FOR SHIPMENT .....	vi
1 INTRODUCTION .....	1
2 GETTING STARTED .....	2
2.1 INSTRUMENT SETUP .....	2
2.2 INSTRUMENT FAMILIARIZATION .....	4
2.3 TEST PROCEDURE .....	4
3 SYSTEM DESCRIPTION .....	6
3.1 HARDWARE .....	6
3.2 HEATING SYSTEM .....	6
3.3 PREDICTION FEATURE .....	6
3.4 CONTROLS .....	7
3.5 DATA OUTPUT .....	8
3.6 WEIGHT DISPLAY .....	8
4 INSTRUMENT SETUP .....	10
4.1 INSTALLATION OF BALANCE PAN SUPPORT .....	11
4.2 AC POWER CONNECTION .....	13
4.3 PRINTER AND/OR COMPUTER SETUP .....	14
4.4 POWER ON .....	14
4.5 NITROGEN PURGE SETUP .....	15
4.6 MAX-1000 N <sub>2</sub> PURGE CONVERSION .....	15
4.7 NITROGEN PURGE CONNECTIONS .....	16
4.8 OUTPUT TO PRINTER .....	17
4.9 ATTACHING AND CONFIGURING THE PRINTER .....	18
4.10 ENABLE PRINTER OUTPUT .....	19
4.11 DATA OUTPUT TO A COMPUTER .....	20
5 MENU SYSTEM: INSTRUMENT CONFIGURATION AND OPERATION .....	21
7 "MENU" KEY: ACCESSING THE MAIN MENU .....	24
7.2 MEMORY START MENU .....	25
7.2.1 ADD/EDIT MEMORY START .....	26
! SAMPLE NAME .....	26
! TEMPERATURES .....	26
▶ Test Temperature .....	27
▶ Histart Temperature .....	27
▶ Idle Temperature .....	28
▶ Start Temp Control .....	29

!	ENDING CRITERIA .....	29
▶	End Test on Prediction .....	30
▶	End Test on Rate .....	30
!	SAMPLE SIZE OPTIONS .....	31
!	TARE OPTIONS .....	32
▶	Pan Tare Options .....	32
▶	Sample Tare Option .....	34
!	RESULT DISPLAY OPTIONS .....	35
7.2.2	REORDER MEMORY START .....	35
7.2.3	DELETE MEMORY START .....	35
7.2.4	PRINT MEMORY START .....	35
7.3	STORED DATA .....	36
7.3.1	VIEW STORED DATA .....	36
7.3.2	PRINT STORED DATA .....	36
7.4	CALIBRATION MENU .....	37
7.4.1	CALIBRATE BALANCE .....	37
7.5	SETUP MENU .....	38
7.5.1	PRINTER SETUP .....	38
7.5.2	REPORT SETUP .....	39
!	REPORT CONTROL OPTIONS .....	40
!	REPORT ITEMS TO PRINT .....	40
!	ENTER/EDIT COMPANY NAME .....	41
7.5.3	CLOCK SETUP .....	42
7.5.4	DATA FORMAT SETUP .....	42
!	ENDING CRITERIA DISPLAY .....	42
!	LOT NUMBER AND PRODUCT ID .....	42
!	SYRINGE TEST .....	43
7.5.5	ACCESS KEY SETUP .....	43
8	“PARAM” KEY: TEMPORARILY CHANGING TEST PARAMETERS .....	45
8.1	CHANGING THE TEMPERATURE SETPOINT .....	45
9	MISCELLANEOUS MENU MESSAGES .....	47
9.1	CONTROL PROGRAM VERSION NUMBER .....	47
9.2	DIAGNOSTIC FAILURE MESSAGES .....	47
10	PERFORMANCE ENHANCEMENT .....	48
10.1	INTRODUCTION .....	48
10.2	DETERMINING PROPER TEST TEMPERATURE .....	50
11	SAMPLE PREPARATION, TESTING AND ANALYSIS .....	52
11.1	SAMPLE PREPARATION .....	52
11.2	OPTIMUM SAMPLE SIZE .....	52
11.3	LIQUID SAMPLES .....	53
11.4	SPEED VS ACCURACY .....	54
11.5	HIGH START TEMPERATURE SELECTION .....	54

12	PERFORMANCE VERIFICATION	55
12.1	WEIGHT TEST	55
12.2	PRECISION WEIGHT TEST	56
12.3	SODIUM TARTRATE TEST	56
12.4	PRECISION TARTRATE TEST	57
12.5	RETAINED SAMPLES	58
13	ROUTINE MAINTENANCE	59
13.1	CHAMBER INTERIOR	59
13.2	HEATER CLEANING	59
13.3	SAMPLE PAN SUPPORT	61
14	TROUBLE DIAGNOSIS	62
15	TROUBLE MESSAGES	64
16	SPECIFICATIONS	66
17	ACCESSORIES & MAINTENANCE PARTS	68
18	APPENDIX A	69
18.1	PARAMETER DEVELOPMENT - CHEMICALS INDUSTRY	69
19	APPENDIX B	72
19.1	PARAMETER DEVELOPMENT - FOODS INDUSTRY	72
20	WARRANTY	74
21	MAINTENANCE CONTRACT	75



# 1 INTRODUCTION

---

The Arizona Instrument MAX-1000 is a high performance moisture analyzer. It uses the proven loss-on-drying method to detect the volatile content of a sample of test material. The instrument uses Arizona Instrument's pioneering prediction method of automatically ending a test to provide accurate results in the shortest possible time.

**Caution:** The MAX-1000 uses a delicate and very sensitive force balance to weigh samples and record very small weight losses. The balance is capable of measuring weight to a resolution of 1 milligram, over a sample weight range from 1 gram to 40 grams. Careful handling is necessary to prevent damage to the balance. With proper care, the instrument will provide years of dependable service.

Typically, the instrument result is precise to better than:

2.0% CV (coefficient of variation) from 0.100% - 100%

It will test at temperatures from room temperature to 225°C, controlled to a precision of plus or minus one degree. The advanced heat control program brings the sample up to temperature in less than three minutes. Depending on the rate of volatilization of the sample moisture, test results are available in as little as two minutes, twice as fast as older instruments of this type.

The instrument is programmable through the simple to understand front panel menu system. For plant control purposes, the programming features can be placed under access code control, preventing unwanted changes to operating parameters. Advanced computer circuitry enables the instrument to store test parameters for 5 different materials. Test data can be printed and may also include graphical representations of the drying process. Test data is stored and can be sent directly to a personal computer.

The MAX-1000 printer output is compatible with the Centronics parallel printer interface, widely used as the standard personal computer printer format.

## 2 GETTING STARTED

---

**This section is for those who can't bear to take the time to read instruction manuals before trying things out.**

Call Arizona Instrument (AZI) Customer Service or your Sales Representative at (800) 235-3360 or (602) 470-1414 if you have any questions about the items below.

For those familiar with moisture analysis instruments, the MAX-1000 should be simple to operate. If you are unfamiliar with this technology, **please read all of the sections of this manual before attempting your first analysis.** The sections starting at SYSTEM DESCRIPTION (page 6) provide the detail on the instrument, operating principles, and sampling.

### 2.1 INSTRUMENT SETUP

---

Setting up your instrument for operation requires just a few steps. For more detailed information on hardware assembly, see the section on SYSTEM DESCRIPTION on page 6. Listed here are the main steps.

Carefully unpack the instrument and locate the following items:

MAX-1000 (AZI p/n MAX-1000)  
Smaller box containing a pan support (AZI p/n 355-0016), balance adaptor and balance cover  
MAX-1000 Accessory kit (AZI p/n Y990-0061)  
Line cord (AZI p/n 200-0002)  
Package of sample pans (AZI p/n 990-0008 or 990-0010)  
Test weights: 3 grams (AZI p/n 690-0003)  
                  5 grams (AZI p/n 690-0004)  
                  20 grams (AZI p/n 690-0007)  
Tweezers (AZI p/n 690-0012)  
Hex wrench (AZI p/n 690-0011)  
This MAX-1000 user's manual (AZI p/n SS-187)  
Optional accessories:  
    Printer (AZI p/n 990-0044)  
    Printer cable, 6' (AZI p/n 600-0105)  
    RS-232 cable [null modem for computer interface] (AZI p/n 6000-1044)  
    Filter paper (AZI p/n 990-0003)

Please save the shipping box (AZI p/n 751-0008) for future use.

## Location Selection

Select a location for the instrument that is:

- ! Firm and level,
- ! Free from vibration that will affect the balance measurements,
- ! Close to an isolated power outlet that will provide dedicated electrical power, and
- ! Away from the direct flow of a fan or heating/air-conditioning outlet that might produce lifting force on the balance.

Install the pan support.

Connect the nitrogen purge lines if used (page 15).

Connect a printer if used (page 17).

Connect a computer if used (page 20).

Ensure the AC power receptacle is set for the correct voltage (120 or 240 VAC). (page 13)

The MAX-1000 will draw up to seven (7) amps. Ensure the instrument is plugged into its own **DEDICATED and GROUNDED** electrical power outlet. Do not put it on a circuit with motors, blenders, heaters, coolers, grinders, or other high current electrical devices. However, a low current (less than one amp) device would be safe.

Turn the instrument on by pressing the switch on the back of the analyzer above the power receptacle.

Adjust the contrast as necessary to view the screen display.

The MAX-1000 is now ready for use.

## 2.2 INSTRUMENT FAMILIARIZATION

---

- 2.2.1 Before beginning the first moisture analysis, allow the instrument to warm up for 30 minutes. After this warm up, calibrate the balance using a clean sample pan and the 20 gram weight provided. (See CALIBRATE BALANCE on page 37.)
- 2.2.2 To become familiar with the instrument and to ensure proper calibration, run a weight test. Select the pre-programmed WEIGHT TEST memory start. Use the five gram and three gram weights supplied with the instrument. Start a test by pressing the “START” key. When commanded to “Load Sample,” put both weights on the sample pan. After the MAX-1000 has finished weighing the sample, and the DATA DISPLAY appears, open the lid and remove the smaller weight. Wait for the test to end. The indicated weight loss percentage should be 37.500%, +/-0.020% for a test using the five and three gram weights.

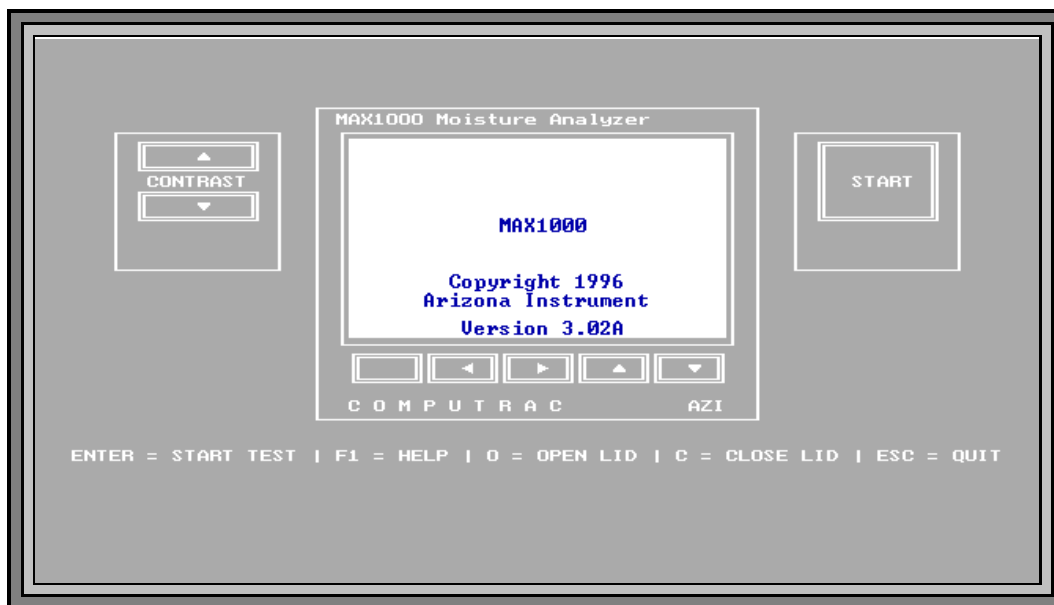

Figure 2 MAX-1000 OPENING SCREEN

## 2.3 TEST PROCEDURE

---

- 2.3.1 This section on TEST PROCEDURE briefly describes the steps in running a test on a product sample. For a more complete description on testing and sampling, see the PERFORMANCE ENHANCEMENT section that starts on page 48.

**CAUTION:** Mechanical stops offer some limited protection to the balance mechanism from overload damage caused by vertical forces. To prevent damage to the balance, use care not to push, pull, or bump the sample pan support excessively.

- 2.3.2 Obtain a sample of test material and transport it in an airtight container to prevent moisture gain or loss through contact with the atmosphere. If the instrument has already been configured for your test material, simply place a clean sample pan on the pan support, press “START” and follow the instructions displayed on the screen.
- 2.3.3 See later sections of this manual for detail on testing a new material (page 48, PERFORMANCE ENHANCEMENT) and storing the test setup for future use (page 25, MEMORY START MENU).
- 2.3.4 For the test, set the temperature to an appropriate value for your first sample. If you are using a reference method such as an air or vacuum oven, use the same temperature for this first sample determination test.
- 2.3.5 Continue as before, by installing a clean dry sample pan and pressing “START.” When LOAD SAMPLE appears on the display, add sample. (For best results, if the instrument displays LOAD SAMPLE, but the balance stored a tare weight greater than +/- 0.1 gram, press “ START” key again. If it will not zero, quit the test and start again.) Load the sample taking care to distribute it evenly across the width of the pan to get the fastest and most accurate results. To load difficult samples more easily, remove the sample pan from the instrument after the sample has been placed on the pan and place it on a work surface. Spread the sample as required. Then replace the loaded sample pan on the pan support and close the cover.
- 2.3.6 To initially determine performance on a given product, under a given set of test conditions, repeat each test five or more times to obtain reliable information about the standard deviation of a typical result. The most recent test result is automatically stored. (Select “Menu” from the front panel of the TEST DATA screen, then go to the STORED DATA MENU.

## **3 SYSTEM DESCRIPTION**

---

### **3.1 HARDWARE**

---

The MAX-1000 is a high performance loss-on-drying moisture analyzer. It consists of a small convection air oven, a weighing mechanism with a resolution of 1 milligram and a full scale range of 40 grams, and a backlit, graphic liquid crystal display. A microprocessor controls the test process, does all necessary calculations, and oversees data handling and communications. A small fan maintains the electronics at a stable, low temperature. Provisions for connection of a printer and serial communications devices are provided at the back. The power input module can be set for either 100-120 volts or 220-240 volts (**Figure 7**, page 13).

### **3.2 HEATING SYSTEM**

---

The sample heating system is designed to remove volatile components from the sample as quickly as possible, while maintaining accurate temperature control to prevent sample degradation. Oven temperature is measured with a platinum resistance device (RTD), mounted in a rugged metal tube to prevent damage and dislocation. Temperature control accuracy is within one degree of the set value after equilibrium is reached. The 700 watt heater reaches equilibrium in 90 to 180 seconds, depending on the difference between the starting temperature and the setpoint. Closed loop feedback control assures a constant temperature even if power line voltage varies during the test. Heat is automatically turned off when the test is completed. Open the lid to speed cooling for the next test, if needed.

### **3.3 PREDICTION FEATURE**

---

The MAX-1000 uses an advanced version of the AZI moisture prediction system to speed test results, and to automatically end each test. The prediction system relies on the fact that most samples exhibit a weight loss trend such that the rate of volatilization is proportional to the amount of volatile material remaining in the sample. The resulting weight trend approximates an exponential function, and the prediction algorithm models this exponential function continuously, updating the prediction each second. When the prediction is sufficiently stable and reliable, the test ends and the predicted endpoint is displayed and printed if an accessory printer is attached. Proper selection of the ending criteria can greatly improve the test times and repeatability. See the section on ENDING CRITERIA, page 29, for more information about this subject.

## 3.4 CONTROLS

- 3.4.1 The front panel controls consist of two arrow keys at the left used to adjust the display CONTRAST, five small keys below the display labeled Help, ◀, ▶, ▲, ▼, and a large “START” key at the right side of the panel.

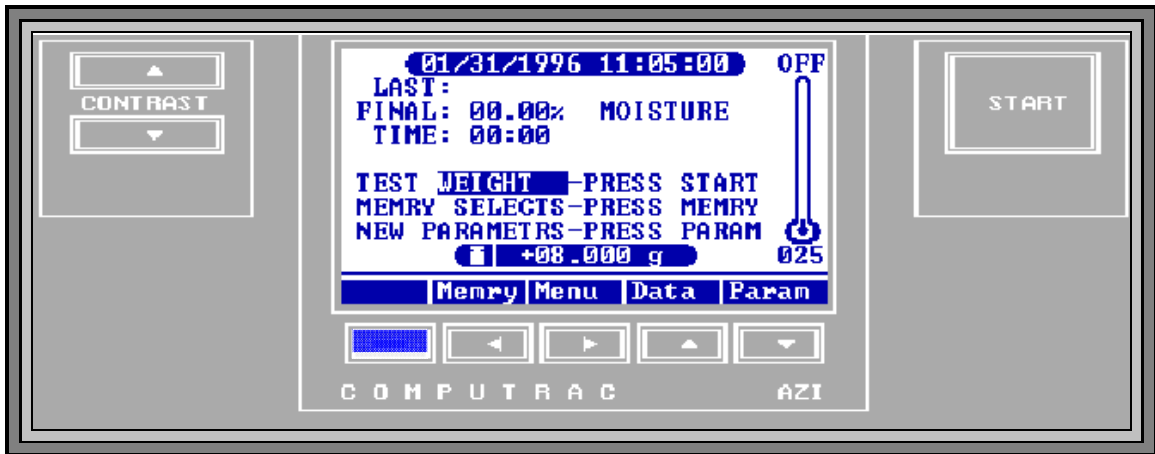

**Figure 3** MAX-1000 FINAL TEST SCREEN

- 3.4.2 The “START” key is pressed to inform the instrument that a moisture determination is to begin. If all system parameters have already been selected, no other key strokes are required to complete a test. Simply follow the steps as they appear on the screen, and wait for the audible signal at the end of the test.
- 3.4.3 The four arrow keys (◀, ▶, ▲, and ▼) are used to navigate through the menu system, and to respond to prompts on the screen. As an example, the ▼ key (down arrow) can be pressed any time during a test to end the test. The “Quit” prompt above the key indicates that the test will be canceled when the key is pressed.
- 3.4.4 When using the menu system to change a numeric value, such as temperature, use the right and left arrow keys to select the digit to be changed, and the up and down keys to increase or decrease the value of the digit. When the changes are completed, use the right arrow key to move the cursor off the end of the number to show completion, and the up or down keys to accept or cancel the changes made. Prompts to remind the user of these conventions are always displayed above the keys when in the value changing modes.

## 3.5 DATA OUTPUT

---

- 3.5.1 Test results are displayed on the main panel and can be sent to a printer or to a computer.
- 3.5.2 At the lower left of the front panel, one of five small icons is always displayed. The left-most icon is a small rotating triangle, which shows that a test is in progress. When the test is completed, rotation will stop. The next icon position to the right shows if the lid is open. The center icon looks like a light bulb, and it shows that power is being applied to the heater. The next icon position, a check mark, indicates a test is done. The last icon on the right is a tilted balance, and it shows that the weighing mechanism is being adjusted in preparation for a moisture determination. If the balance icon is displayed, then the balance is momentarily unstable or off-line.
- 3.5.3 The MAX-1000 can output data to a printer or to a computer for storage. For printer output, connect a standard PC parallel printer to the MAX-1000 printer port. For communications with a computer, connect a null modem cable between the MAX-1000 RS-232 port and a computer running communications software. Call Arizona Instrument Customer Service for more information on this software.

## 3.6 WEIGHT DISPLAY

---

- 3.6.1 The internal balance weight reading is always visible on the screen when in the operating mode.
- 3.6.2 While loading the sample, the weight is displayed in grams at the bottom of the screen and on a horizontal bar at the top. The nominal weight is entered under SAMPLE SIZE OPTIONS. Add the sample so that the solid bar is at or near the optimal weight.
- 3.6.3 While a test is in progress, the horizontal bar is not displayed. Only the weight in grams is displayed at the bottom center of the screen (shown as +08.000 grams in **Figure 4**).

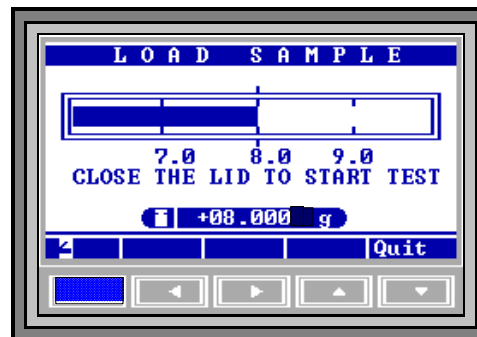

**Figure 4** WEIGHT DISPLAY

3.6.4 After “START” has been pressed, a weight error message may appear on this screen. For example, if no pan or pan support is on the balance, UNDERLOAD will be displayed. If the weight on the sample pan exceeds 40 grams, OVERLOAD will be displayed. If an empty sample pan is in place, and either of these displays appear, **turn the unit off** , remove the sample pan, pan support, the circular balance shield and clean any debris found beneath the pan support. Reassemble the parts and be sure that no mechanical interference is present. It may be necessary to calibrate the balance (see page 37). If these measures fail to restore normal function, call AZI Customer Service at (800) 235-3360 or (602) 470-1414 for assistance.

## 4 INSTRUMENT SETUP

---

Unpack the instrument as previously described on page v.

**SAVE THE BOXES AND ALL PACKING MATERIALS. IF THE UNIT IS SHIPPED FOR ANY REASON, THE INSTRUMENT MUST BE SHIPPED IN ITS PROTECTIVE PACKAGING MATERIALS.**

Check the packing list with the MAX-1000 to ensure that all items have been received.

Remove the instrument from its protective wrapping, and place it on a firm, level work surface. Be sure there is enough clearance at the back for the power cord, and above the unit, for the cover. If the instrument is cold, for example if received in cold weather, it may need to warm up to room temperature to allow the display and other electronics to work properly.

## 4.1 INSTALLATION OF BALANCE PAN SUPPORT

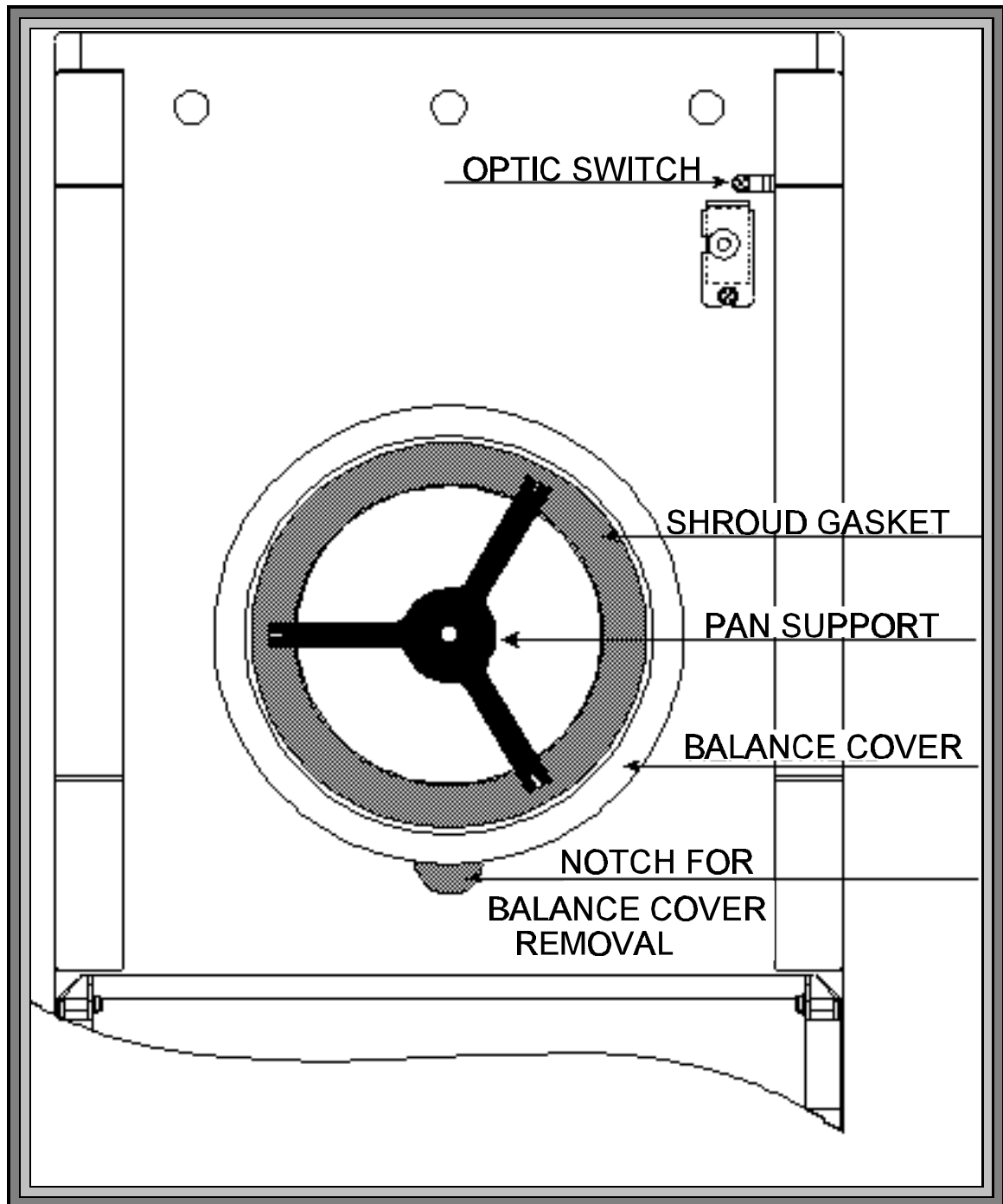

**Figure 5** MAX-1000 ASSEMBLED HEAT TABLE

- 4.1.1 Open the lid by lifting the handle just above the display. **CAUTION:** Excess pressure can damage the force balance.

**NOTE: The white foam disk that is found on top of the chassis, and held in place by three tapered pins on the heat table is there for insulation. DO NOT REMOVE IT.**

Remove the balance cover/balance adaptor assembly from its packing box.

The pan support is in the top opening of the balance cover. The balance adaptor is below the balance cover and aligned with the pan support. Test the fit between the balance adaptor and the pan support to be sure it is snug. See **Figure 6**.

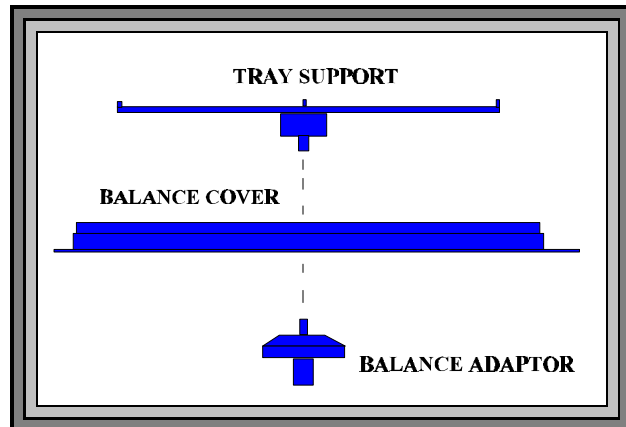

**Figure 6** ADAPTOR/SUPPORT ASSEMBLY

Align the holes in the bottom of the balance cover with the pins on the heat table.

Allow the balance adaptor to gently drop through the hole in the heat table and into place on the tapered force balance shaft.

Gently align the balance cover to the tapered pins and press into place.

- 4.1.2 Check the clearance between the pan support arms and the balance cover by observing the space between the arms and the balance cover. The clearance should be about one millimeter . If the clearance is considerably different than one millimeter or the pan support appears to be crooked, then call AZI Customer Service, (800) 235-3360 or (602) 470-1414.

## 4.2 AC POWER CONNECTION

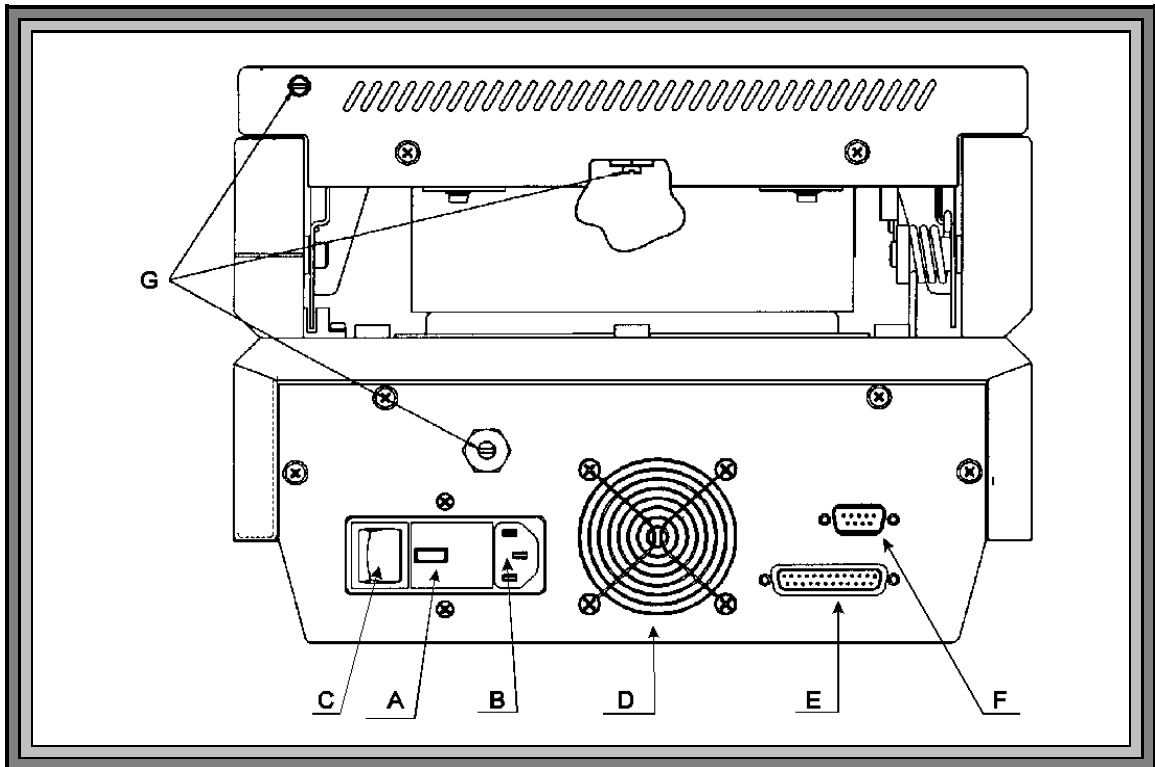

**Figure 7** MAX-1000 REAR VIEW

Labeled: Voltage Requirement/Fuse Holder (A), Power Receptacle (B), Power Switch (C), Fan (D), Printer Interface (E), RS-232, 9 Pin Computer Interface (F), Nitrogen Purge Fittings (G).

4.2.1 The MAX-1000 can be used with either 120 or 240 VAC. Check the setting on the fuse holder ("A" on **Figure 7**) for correct voltage (100-120 or 220-240 volts) from your power receptacle.

4.2.2 To change from 110 to 220VAC, or from 220 to 110VAC:

! Remove the tab in the fuse holder and reverse the small card inside.

! Change the fuse: a 100-120 unit should have an eight (8) amp slow blow fuse, (AZI P/N 190-1001) and a 200-240 unit should have a (4) amp slow blow fuse (AZI P/N 190-1002).

! Slide the card in the center of the fuse holder out, turn it around, and slide it back in so that the correct voltage shows through the window ("A" on **Figure 7**).

4.2.3 Remove the power cord from the packing material and insert the rectangular end into the power receptacle ("B" on **Figure 7**) at the rear of the instrument. Be sure that the power switch ("C" on **Figure 7**) located above the power receptacle is in the off (O) position.

- 4.2.4 The power source outlet used by the MAX-1000 **MUST BE GROUNDED**. (If you are not sure if the socket is grounded, check with your plant electrician before proceeding). The MAX-1000 will appear to function correctly even if the socket is not grounded, but there is a danger of possible electrocution! If grounded outlets are not available, consider using a ground fault interrupter to protect personnel against electrical shock.
- 4.2.5 Also, noise on the power lines may affect accuracy. A dedicated AC power line or an isolation transformer for the MAX-1000 may be beneficial in eliminating this noise.

### **4.3 PRINTER AND/OR COMPUTER SETUP**

---

- 4.3.1 If you have a printer, connect it to the larger of the two "D" connectors ("E" on **Figure 7**) at the rear of the instrument. Use any standard Centronics parallel PC printer and printer cable. (Test information will print at the end of each test, or at preset intervals. For more details, see **PRINTER SETUP** on page 38 and **REPORT CONTROL OPTIONS**, page 40.)
- 4.3.2 If you would like data output to a computer, attach a null modem cable to the 9-pin, RS-232 connector ("F" on **Figure 7**). See the section on **DATA OUTPUT TO A COMPUTER**, page 20 for more information.

### **4.4 POWER ON**

---

- 4.4.1 Make sure instrument is OFF. Plug the power cord into a power outlet. Press the MAX-1000 power switch ("C" on **Figure 7**) at the end marked (I). Observe that the fan ("D" on **Figure 7**) next to the power receptacle begins to rotate. If it does not, check to be sure that power is present at the outlet being used.
- 4.4.2 Observe that the front panel screen is illuminated, and the AZI logo appears momentarily. Adjust the screen contrast with the large up/down arrows at the left of the front panel, labeled **CONTRAST**. If no text is visible on the screen, press and hold the up arrow for thirty seconds, then press and hold the down arrow for fifteen seconds. (NOTE: In some situations, when the instrument has been exposed to cold temperatures, the display may appear to be erratic. In those situations, open the display panel and allow the instrument and the display to warm up to room temperature.)

## 4.5 NITROGEN PURGE SETUP

---

- 4.5.1 Some applications (such as black liquor solids analysis) require the use of a nitrogen purge to remove volatiles from the chamber. If a nitrogen purge is to be used, and your instrument is factory equipped with the "nitrogen purge" option, attach the diffuser to the inside of the heater box and the hose barbs and tubing to the round ports on the rear of the lid and instrument body ("G" on **Figure 7** on page 13).

**CAUTION: Use of nitrogen or other inert carrier gas does not create an explosion-proof system.**

## 4.6 MAX-1000 N<sub>2</sub> PURGE CONVERSION

---

- 4.6.1 Open the heater lid.
- 4.6.2 Remove the plug which is centered in the heater ring.

**NOTE:** Use caution when installing the muffler. Tighten it finger tight only to prevent breakage.

- 4.6.3 Install the muffler and seal in the opening created by removing the plug.
- 4.6.4 Close the heater lid.
- 4.6.5 From the back of the unit, remove the plug located in the upper left corner (as viewed from the rear) of the heater lid.
- 4.6.6 Install the .007 orifice fitting (it has the green insert) into the opening created when the plug was removed.
- 4.6.7 From the back of the unit, remove the plug from the lower portion of the unit, (see **Figure 7** ).
- 4.6.8 Install the .012 orifice fitting (it has the black insert) into the opening created when the plug was removed.

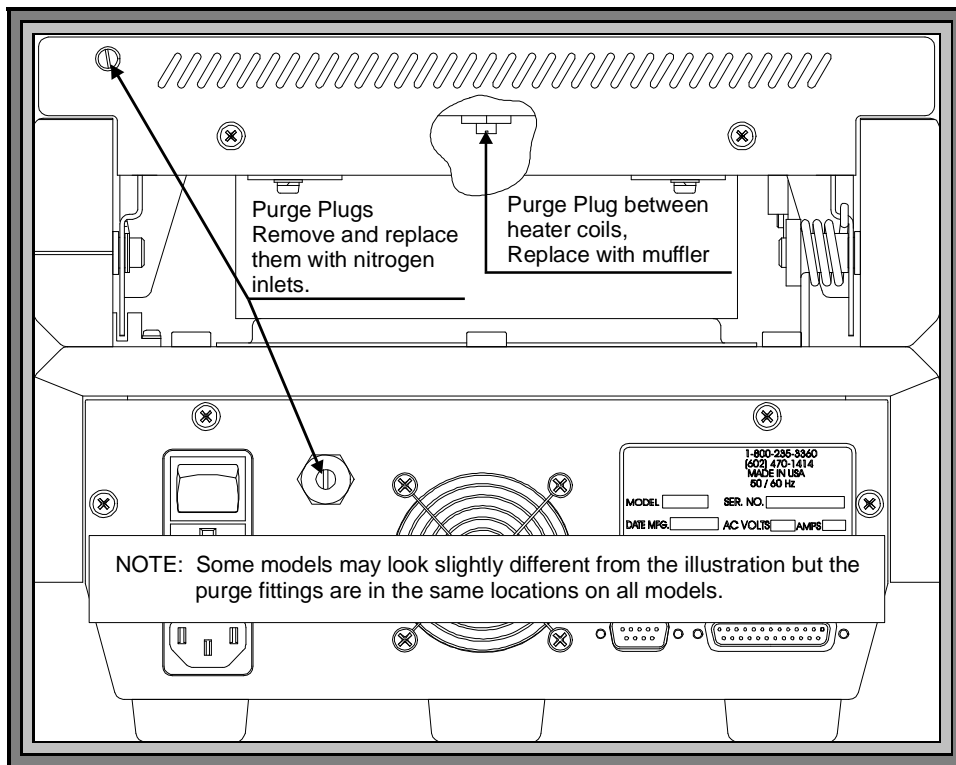

**Figure 8** NITROGEN PURGE FITTING LOCATIONS

## 4.7 NITROGEN PURGE CONNECTIONS

4.7.1 The following materials will be required for the nitrogen purge setup:

- ! Nitrogen source/cylinder or other supplied inert gas source
- ! Two-stage regulator capable of regulating pressure to 5 psi
  - ▶ For cylinder applications: Multistage Gas Regulator for Compressed Air Cylinder, VWR #55850-150, # 55850-155 or equivalent, or Matheson Gas Products Brass Dual Stage Regulator, model 8L or equivalent
  - ▶ For supplied gas sources: Matheson Gas Products Model 3470 Series Single Stage Line Regulator, model 3471
- ! Tubing with a 1/8" (.31 cm) inside diameter (I.D.) And, 1/4" (.625 cm) outside diameter (O.D.)
  - ▶ Vinyl tubing (VWR #63013-029), or
  - ▶ Nalgene clear plastic tubing (Nalge #8000-0020, VWR #63015-368)
- ! Connector, 1/8" I.D., 1/4" O.D.
  - ▶ Nalge "Y" connector #6152-0250, VWR #62850-060, or
  - ▶ Any suitable 1/8" I.D., 1/4" O.D. "T" connector

4.7.2 Connect the regulator to the gas source/cylinder per the regulator manufacturer's instructions.

4.7.3 Use tubing to connect the outlet of the regulator to the connector.

- 4.7.4 Connect tubing from the connector's two outlets to the fittings on the rear of the unit.
- 4.7.5 Check that all fittings are gas tight and secure. Pressure should be deferred until the start of a test to conserve gas use. Flow rates between 4 and 5 psi are sufficient. **Figure 9** shows the nitrogen purge setup.

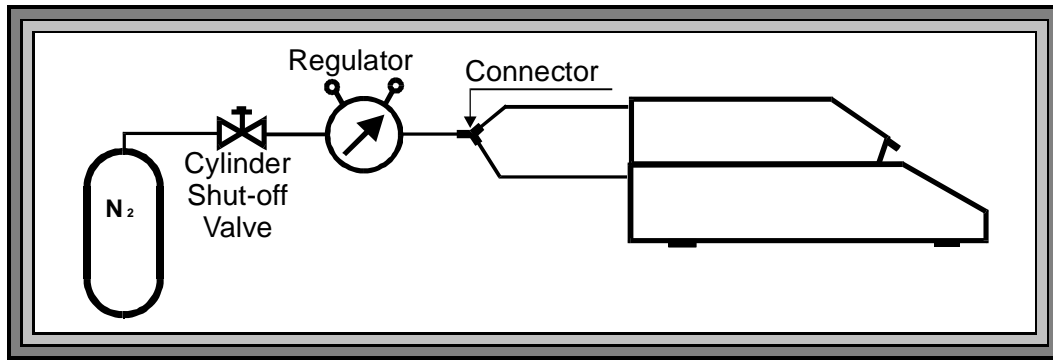

**Figure 9** NITROGEN PURGE SETUP

## 4.8 OUTPUT TO PRINTER

---

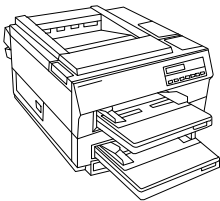

An optional data printer is available from AZI (pictured is printer example only). It connects to the printer port at the rear of the instrument. This port is a standard PC parallel printer port, so standard printers and cables can be used. The content of each message to be printed can be custom configured from the menu system. Normally, messages are only printed at the end of a test, but other types of reports are available from the menu. These same messages can also be directed to the RS-232 serial port at the back of the instrument.

## 4.9 ATTACHING AND CONFIGURING THE PRINTER

- 4.9.1 Unpack the printer, cable and paper. Install the paper according to the instructions in the printer manual. Plug the large end cable connector into its mating socket on the printer, and the small end into its mating socket on the back of the MAX-1000. Plug the power cord into the printer, and into a GROUNDED power receptacle. Turn the printer power on and observe that it lights up. Press the “ON LINE” button to bring the printer on line.
- 4.9.2 After the printer is attached, configure the MAX-1000 to the proper printer type, IBM or Epson compatible. (See printer manual for compatibility.)

NOTE: If the printer is supplied with the MAX-1000 from AZI, the unit is already programmed. If the printer is obtained from another source, refer to its manual for programming information.

- 4.9.3 To set up the MAX-1000, begin at the OPENING MENU and Press the “Menu” key. Press the “Down” key until the select bar is on SETUP MENU and press the “Selct” key.

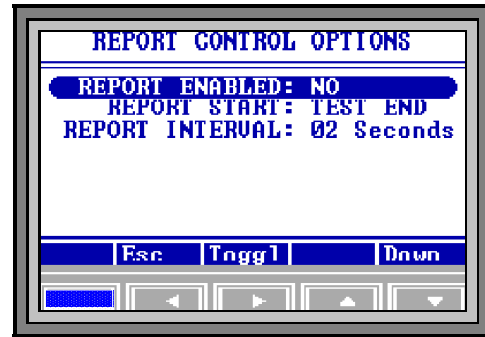

Figure 10 SETUP MENU

- 4.9.4 The select bar should be on PRINTER SETUP so just press the “Selct” key.
- 4.9.5 The select bar should be on PRINTER TYPE. Press the “Edit” key, to allow the selection to be changed. Press the “Incr” key or “Decr” key to change the selection between IBM and Epson. When the correct type is displayed, press the “Acpt” key to lock the selection into the MAX-1000 parameters.
- 4.9.6 Move the select bar to OUTPUT PORT and press the “Edit” key, to allow the selection to be changed. Press the “Incr” key or “Decr” key to change the selection between LPT, RS-232 and Both. When the correct port selection is displayed, press the “Acpt” key to lock the selection into the MAX-1000 parameters.
- 4.9.7 Select both ports if the output is to be directed to both the printer and the RS232 serial port for computer communications.
- 4.9.8 Move the select bar to AUTO FORM FEED and press the “Toggle” key to select between OFF and ON. When the correct selection is displayed, press the “Esc” key two times to return to the OPENING MENU.

## 4.10 ENABLE PRINTER OUTPUT

4.10.1 With the OPENING MENU displayed, press the “Menu” key to display the MAIN MENU. Go down to the SETUP menu and press “Selct.” Highlight REPORT SETUP and press “Selct” again. With REPORT CONTROL OPTIONS highlighted, press “Selct” again.



**Figure 11** REPORT ENABLED

- 4.10.2 With REPORT (Print) ENABLED highlighted, press the “Toggle” key, to select between YES and NO. Select YES to send the test results to the printer and NO to stop results from being sent to the printer.
- 4.10.3 Select REPORT START and press the “Edit” key. Press the “Incr” or “Decr” keys as necessary to select either START TEST, 1st PRED (first prediction), or TEST END.
- 4.10.4 Select REPORT INTERVAL and press the “Edit” key. Press the “Incr” or “Decr” keys to select an interval between the minimum of 02 seconds and the maximum of 99 seconds. Press the “Accpt” key to lock the selection into the MAX-1000 parameters.
- 4.10.5 Press the “Esc” key to return to the REPORT SETUP MENU.
- 4.10.6 Move the select bar to REPORT ITEMS TO PRINT and press the “Selct” key. Move up and/or down through the list and select the items to be printed.
- 4.10.7 Press the “Esc” key until the OPENING MENU is displayed.
- 4.10.8 To verify that the MAX-1000 and the printer are connected and working together, run a weight test. The printer output is automatically enabled when either a weight test or a tartrate test is selected.

## 4.11 DATA OUTPUT TO A COMPUTER

---



If you wish to monitor the test with a computer, connect a null modem cable to the smaller of the two "D" connectors at the rear of the instrument. Use any serial port communications program (not provided) on your computer to read the messages emitted at the MAX-1000 serial port. The content of each message can be selected from the REPORT ITEMS TO PRINT menu which is described on page 40.

4.11.1 The MAX-1000 comes equipped with RS-232 communications available at a 9-pin standard serial communications socket at the rear of the instrument. The standard communications parameters used are 9600, N, 8, 1 (9600 baud, no parity, eight data bits, one stop bit). Refer to your computer communications program manual for instructions on configuring the PC to read this data format. The MAX-1000 is configured as an RS-232 DTE (data terminal equipment) device. The following table lists the pins used:

<b>Pin #</b>	<b>Function</b>	<b>Explanation of function</b>
<b>1</b>	<b>N/C</b>	
<b>2</b>	<b>RX</b>	<b>Data in to MAX-1000</b>
<b>3</b>	<b>TX</b>	<b>Data out from MAX-1000</b>
<b>4</b>	<b>DTR</b>	<b>MAX-1000 is ready to send (not used in this release)</b>
<b>5</b>	<b>GND</b>	<b>Ground reference for signals</b>
<b>6</b>	<b>DSR</b>	<b>Used to indicate connected device is ready</b>
<b>7</b>	<b>RTS</b>	<b>Request to Send (not used in this release)</b>
<b>8</b>	<b>CTS</b>	<b>Clear to Send (not used in this release)</b>
<b>9</b>	<b>N/C</b>	

4.11.2 Currently the MAX-1000 does not test to see if the connected device is actually ready (or even present), nor does it respond to a request by the connected device for status information.

4.11.3 Since the MAX-1000 can send data to both the RS-232 port and the parallel printer port at the same time, the same procedure to direct the output to printer routes the output to the computer.

4.11.4 The same data is output to both the printer and the RS-232 ports. logging programs. If you have any questions about the instrument setup, please call AZI Customer Service at (800) 235-3360 or (602) 470-1414 for assistance.

## 5 MENU SYSTEM: INSTRUMENT CONFIGURATION AND OPERATION

---

The MAX-1000 is controlled by various parameters entered via the displayed commands and keyboard operations. This entire set of commands and displays is called the menu system, because each screen offers a series of choices, selected by specific keystrokes. Page 22 shows a diagram of the menu structure of the MAX-1000 which is arranged in a sequentially-accessed tree of screens.

- 5.1 The FINAL TEST screen will appear when the system is first started. This screen displays the current date, time, last test parameter set name, last test result, last elapsed test time, and the temperature setpoint. The current parameter set name and prompts relating to the function keys are in the center of the screen.

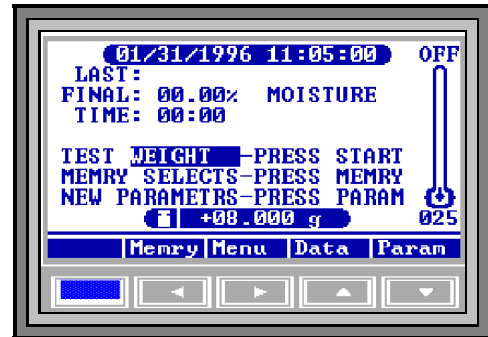
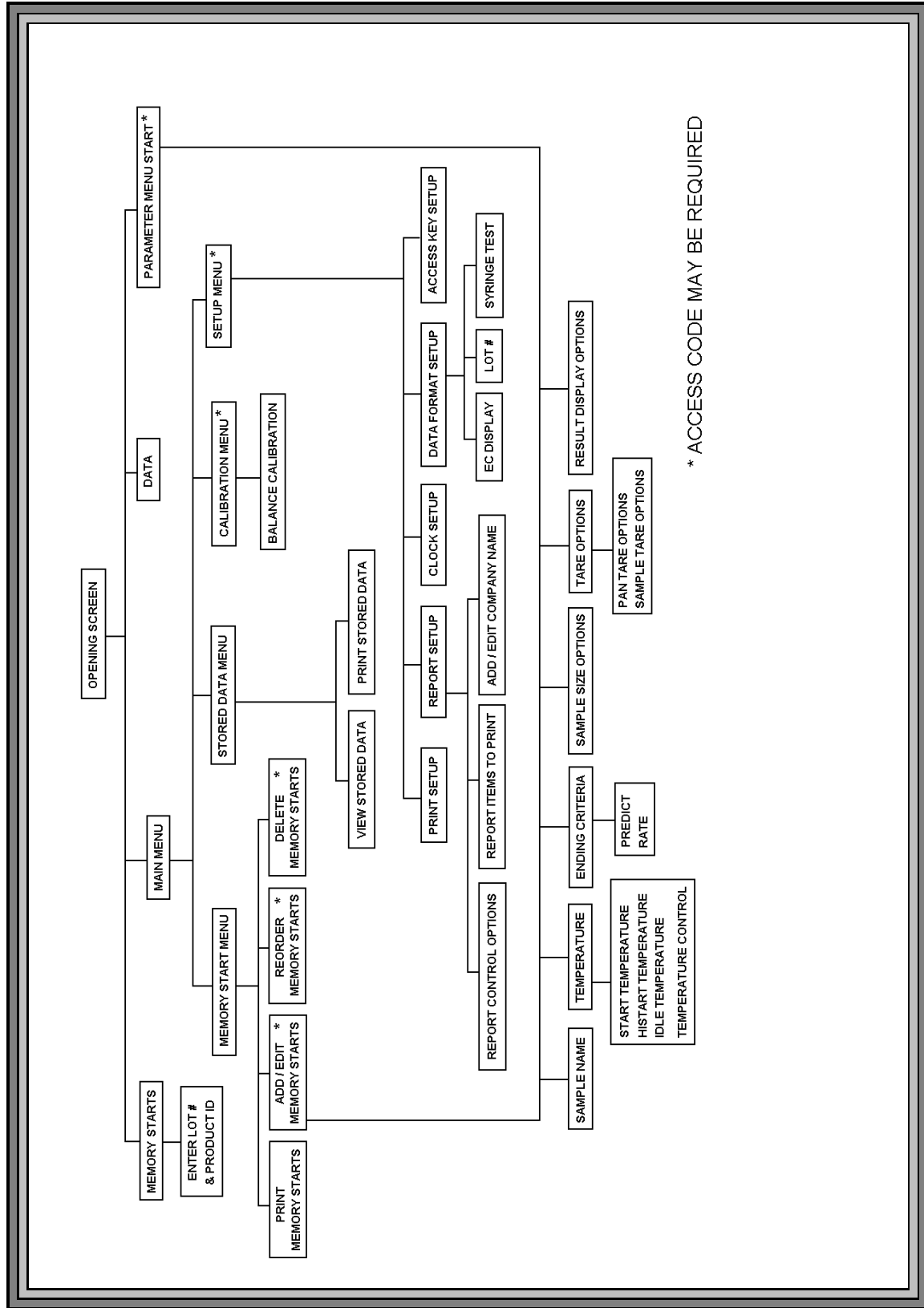

**Figure 12** FINAL TEST SCREEN

- 5.2 When a test is completed, the values at the end of the test are displayed. They will be displayed until “START” is pressed to begin another test. A highlighted bar at the bottom of the screen shows the balance reading. At the right is a symbolic thermometer with the current heat chamber temperature displayed both graphically and numerically.

The bottom row shows prompts suggesting the function of the five keys arrayed across the bottom edge of the display. The left arrow key (“Memry”) goes to the stored sets of test parameters (Memory starts). The right arrow (“Menu”) gets to the main menu of the menu system. The up arrow key (“Data”) provides select data on the most recent test. If the test is complete, the full test is shown. If the test is in progress, a triangle at the bottom left will rotate and the current moisture trend to the present time is shown.

- 5.3 Once a test is under way, test parameters cannot be changed until the test is completed or terminated (“Quit” key). Before running a test, the down arrow key (“Param”) will access menus that allow the test parameters to be changed for the next test. The test temperature is the value most often changed. The manual describes methods of storing parameter sets for particular test materials in the section on the MEMORY START MENU (page 25).
- 5.4 The menu system can be accessed by pressing the “Menu” key at the FINAL TEST screen if the access code control system is not activated. If access code control is active, edits to the MENU will bring up a message asking for the access code. Successfully entering the correct code will then bring up the MAIN MENU. For more information on the access code, see CHANGE MENU ACCESS CODE on page 43.



\* ACCESS CODE MAY BE REQUIRED

Figure 13 MAX-1000 MENU TREE

## 6 “MEMRY” KEY: MEMORY START SELECTIONS

6.1 The Memry menu branch lists the stored parameter sets used for various applications. This menu is accessed by pressing the button under the word “Memry” on the display.

6.2 Memory Starts are numbered at the left, beginning with 00. A total of 7 different parameter sets can be retained in the system memory. Each has a unique number, and a user entered ID label. Memory starts 00 Weight Test and 01 Sodium Tartrate are preprogrammed for system verification. These are stored in non-volatile memory and can not be changed. Memory start 06 is the



**Figure 14** MEMORY STARTS

The instrument uses this set when first powered up, if no other memory start parameter set has been programmed and selected. This location is also used to store temporary parameter sets entered via the “Param” key at the DATA or FINAL TEST screen.

6.3 Memory start parameter sets numbered 02 though 06 are programmed by using the Menu options to configure the instrument as needed and to store and label the selected memory start parameter set. (See “Menu” key: Accessing the MAIN MENU below).

6.4 To begin a test with a stored parameter set, access the MEMORY START MENU by pressing the “Memry” key at the FINAL TEST screen. Move the selector bar to the desired item with the up and down keys, and press the “START” key. Unless the LOT NUMBER function is selected (see DATA FORMAT SETUP, page 42), the test will start immediately using the parameters stored under the selected label.

## 7 “MENU” KEY: ACCESSING THE MAIN MENU

---

At the FINAL TEST screen, pressing the “Menu” button will display the main level of the menu system. If Access Code control is active, a screen asking for the access code will appear prior to any edits of the stored parameters.

When the screen prompts for the access code, use the arrow keys to select the access code letters. When the last letter is entered, the menu will appear (if the access code entered was correct) or you will be returned to the original display screen. See the section below on access control for more details.



**Figure 15** THE MAIN MENU

The list on the screen will show the menu branches available at any point.

From the MAIN MENU, the following functions are available:

MEMORY START MENU is used to make changes to stored parameter sets.

- ADD/EDIT MEMORY START
- REORDER MEMORY START
- DELETE MEMORY START
- PRINT MEMORY START

STORED DATA MENU is used to work with data from past moisture determinations.

- VIEW LAST TEST DATA
- PRINT LAST TEST DATA

CALIBRATION MENU is used to run balance and heater calibrations.

- BALANCE CALIBRATION
- PRINT BALANCE CAL REPORT

SETUP MENU is used to change instrument default setups.

- PRINTER SETUP
- REPORT SETUP
- CLOCK SETUP
- DATA FORMAT SETUP
- ACCESS KEY SETUP

- 7.1.1 To select a menu item, move the selector bar down the displayed list to the function using the up or down arrow keys. If the list is longer than the screen space, a down arrow will be displayed at the far right bottom of the screen. If the bottom of the list is shown, and options exist above the top of the display, an up arrow will be displayed at the top right. The selected option is displayed at the top of the screen as a reminder. Press the “Selct” key to begin your selection, or the “Esc” key to return to the previous menu level.

## 7.2 MEMORY START MENU

---

This menu accesses and changes the stored parameter sets. At the FINAL TEST screen, press “Menu” to get the MAIN MENU. Select MEMORY START MENU and press “Selct.”



**Figure 16** MEMORY START MENU

Selecting any option from the MEMORY START MENU brings up the list of stored parameter sets. They are sequentially numbered from 00 to 06. Note that 00 ID: WEIGHT and 01 ID: TARTRATE are factory set in non-volatile memory and can not be changed. In addition, 06 ID: CUSTOM can be changed through this menu or using the “Param” key at the FINAL TEST screen

To change a set of parameters, select the number line to be changed and press “Selct”. This will bring up the EDIT TEST PARAMETERS screen. The sample parameters shown on this menu are the same as on the PARAMETERS MENU START shown on page 45, but a test can not be started directly from here.

**7.2.1 ADD/EDIT MEMORY START** - Used to alter or create a stored parameter set.

**EDIT TEST PARAMETERS** - Used to change the following parameters.

**SAMPLE NAME** - Enter an alphanumeric ID for this test

**TEMPERATURES** -Change test, histart and idle temperature set points

**ENDING CRITERIA** -Change automatic test end methods

**SAMPLE SIZE OPTIONS** - Change minimum and maximum sample size allowed

**TARE OPTIONS** - Select tare method parameters

**RESULT DISPLAY OPTIONS** - Select moisture, solids or dry weight basis

**SAMPLE NAME**

To change the sample name for a parameter set, select **SAMPLE NAME** and press “Edit”. The cursor will be positioned at the first character of the name. Press and hold the “Incr” or “Decr” keys until the desired symbol appears. Then press “Right” or “Left” to the next character to be changed. Eight character positions are available. Available characters are: all the uppercase English letters, the digits 0 to 9, and 12 common punctuation marks and symbols. Move the cursor to the left or right to the last position and press “Accpt” to save the name. “Cancl” returns to the menu without any name change.

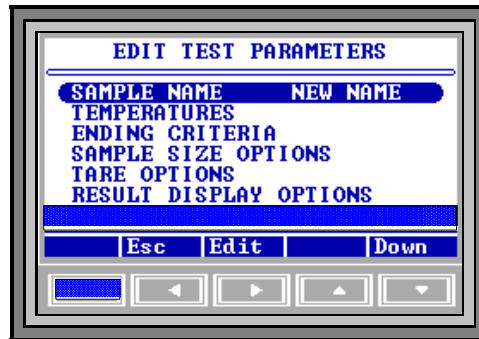

**Figure 17** SAMPLE NAME

**! TEMPERATURES**

To change the temperature setpoint, use the up or down arrow key to move the selector bar to the **TEMPERATURES** option and press the “Selct” key. Move the selector bar to the particular temperature to be changed, either the **TEST TEMPERATURE** the **TEST HISTART TEMP** or the **IDLE TEMPERATURE** and press the “Edit” key.

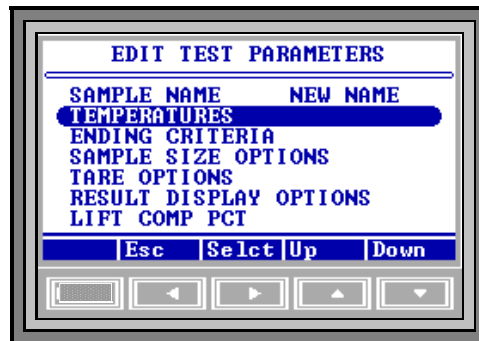

**Figure 18** TEMPERATURES

► Test Temperature

The current setpoint is displayed after TEST TEMPERATURE. Press the “Edit” key . The cursor will be positioned at the first (most significant) digit. Use the up or down arrows to increase or decrease the digit value. Press the right arrow key to move to another digit, and change each appropriately. When finished, move the cursor to the end digit and press the key labeled “Quit”. To register the change, press the key labeled “Acpt.” To cancel the change, press the key labeled “Cancl.” The display remains at the TEMPERA-

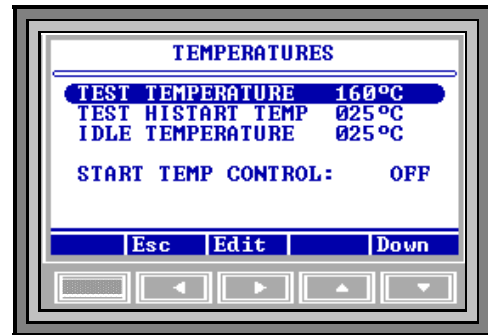

Figure 19 TEST TEMPERATURE

► Histart Temperature

Test speed may be increased for some samples by using the MAX-1000 TEST HISTART TEMP option. The principle behind this feature is that some samples contain free (surface) and bound moisture. This surface moisture can be quickly driven off at temperatures greater than the temperature normally used for that product.

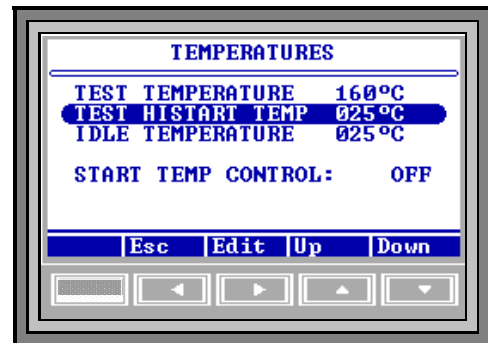

Figure 20 TEST HISTART TEMP

The instrument begins a test at the HISTART TEMPERATURE, and continues at that temperature until the rate of moisture loss falls to half of its peak value. It then goes to the test temperature setpoint for the remainder of the test. For this to work properly, the HISTART TEMPERATURE is usually higher than the test temperature. The MAX-1000 prediction algorithm is so fast, this process is usually not necessary. To deactivate the HISTART feature, set the TEST HISTART TEMP to 25°C.

To change the HISTART TEMPERATURE press “Edit”. The HISTART TEMPERATURE setpoint is displayed after TEST HISTART TEMP and the cursor will be positioned at the first (most significant) digit. Use the up or down arrows to increase or decrease the digit value. Press the right arrow key to move to another digit, and change each appropriately. When finished, move the cursor left or right to the end digit and press the key labeled “Quit.”

To register the change, press the key labeled “Acpt.” To cancel the change, press the key labeled “Cancl.” The display remains at the TEST TEMPERATURE screen. If you accepted the change, note that the new set point is displayed at the top of the thermometer display on the FINAL TEST screen. This is the HISTART TEMPERATURE that will be used when “START” is pressed the next time.

► Idle Temperature

The idle temperature is the temperature maintained by the instrument between tests. This is used to speed testing, by decreasing the time required to heat the sample chamber at the beginning of the test. It can save 10 to 90 seconds of test time if properly used. A common idle temperature value is 50°C but any value above room temperature (but below 150°C) can be used. Experiment to see what value is best for your application. Too high a value will cause low results because the sample is evaporating while the basis weight is being measured at the beginning of the test.

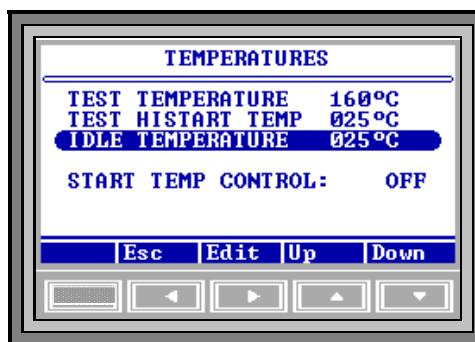

**Figure 21** IDLE TEMPERATURE

The current idle temperature setpoint is displayed after IDLE TEMPERATURE and the cursor will be positioned at the first (most significant) digit. Use the up or down arrows to increase or decrease the digit value. Press the right arrow key to move to another digit, and change each appropriately. When finished, move the cursor to the end digit and press the key labeled “Quit.” To register the change, press the key labeled “Acpt.” To cancel the change, press the key labeled “Cancl.” The display remains at the TEMPERATURES screen. If you accepted the change, note that the new set point is displayed at the upper and lower end of the thermometer display on the FINAL TEST screen. This is the idle temperature that will be used after “START” is pressed the next time.

► Start Temp Control

The START TEMP CONTROL prevents a test from starting if the chamber temperature is more than two degrees (2°C) hotter or colder than the IDLE TEMPERATURE. This feature can improve the standard deviation of results of some temperature sensitive materials. When this feature is enabled (on), an alarm will sound when the chamber temperature is correct.

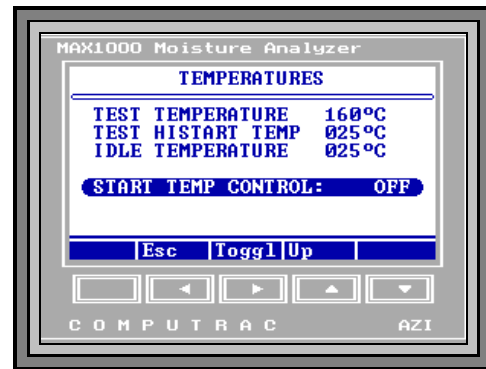

Figure 22 START TEMP CONTROL

If “START” is pressed when the chamber is too hot, the following message will be displayed: CHAMBER TEMPERATURE IS HIGH. Open the lid and wait for the alarm.

If it's too cold, this message appears: CHAMBER TEMPERATURE IS LOW. Leave the lid closed and wait for alarm. When the TEMP CONTROL is disabled (off), a test can be started at any temperature.

! ENDING CRITERIA

Ending criteria are the rules used by the instrument to automatically end a test. This feature makes it unnecessary for the operator to monitor the analyzer while it is performing a test.

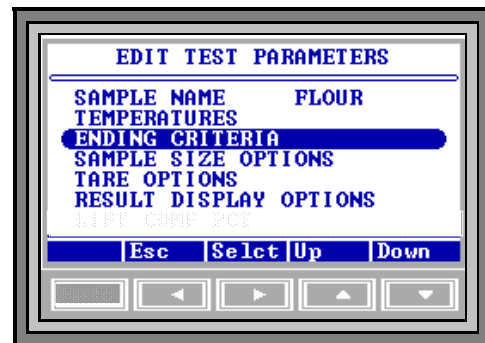

Figure 23 ENDING CRITERIA

Change the ending criteria from the EDIT TEST PARAMETERS menu using the up or down arrow key to move the selector bar to the ENDING CRITERIA option and press the key labeled “Selct”. This displays the ENDING CRITERIA menu.

END TEST ON PREDICTION The test will end when the predicted final value meets certain criteria.

END TEST ON RATE The test will end when the weight loss rate falls below a selected value.

Highlight the ending criterion to be changed and press “Selct.”

► End Test on Prediction

To change the prediction ending criteria, move the selector bar to END TEST ON PREDICTION and press the key marked “Selct.” This will bring up the ending criteria screen, labeled END TEST ON PREDICTION at the top. Highlight the best one for the next test, (TIGHT, MIDRANGE, or RELAXED) and press “Selct.” The triangular selection indicator at the left edge of the screen will show the selection. Press “Esc” to store the selection and return to the previous menu.

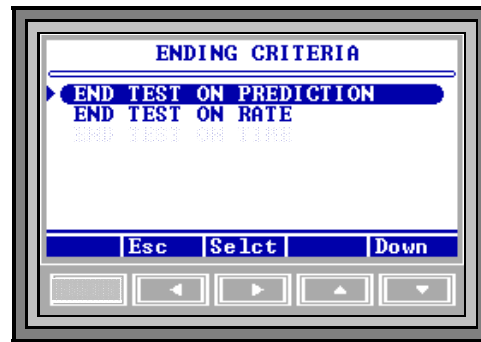

Figure 24 END TEST ON PRED

TIGHT is the most accurate but takes the longest time. RELAXED is the least accurate but is the fastest MIDRANGE gives excellent results in an average amount of time. See the section on PERFORMANCE ENHANCEMENT on page 48 to learn how to determine appropriate settings for each application.

► End Test on Rate

This feature ends the test to when the rate of the weight loss rate falls below a selected value. This value is a percent per minute. For example, entering 0.10 means that the test will end when the rate of change of the actual weight loss is less than 0.10 % per minute.

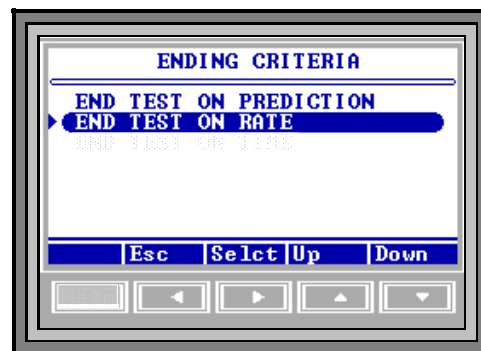

Figure 25 END TEST ON RATE

The instrument's program assumes that the sample contains volatile material that will completely evaporate after some time. It further assumes that, at first, the rate will be large, then gradually decrease to zero. Selecting some threshold rate value will cause the test to end before the sample is completely dry. Rate is useful to profile a sample's weight loss. Some applications are faster in the rate ending criteria. Others are faster in the prediction ending criteria.



Figure 26 RATE CRITERIA

Some samples contain more than one volatile material, for example nylon resins with large amounts of unpolymerized material (Caprolactam). In these cases, the rate will fall to some fixed value when all the moisture is evaporated, but the monomer is still evaporating. The graphical display available from the FINAL TEST screen is of great help in visualizing these cases. The rate ending criteria, if set above the rate of monomer volatilization, may give the best results.

To change the rate ending criteria, move the selector bar to END TEST ON RATE and press the key marked "Selct." The following screen, END TEST ON RATE appears and the "Selct" key becomes the "Edit" key. Press this key, to change the value, (or the "Esc" key to leave without making any changes). The cursor will appear on the first digit. Move the selector to the digit to be changed and use the "Incr" or "Decr" keys to change it. Press "Quit" when finished. Press the "Acpt" key to record the new values, or "Cancl" to revert to the previously stored value. Press the "Esc" key to return to the ENDING CRITERIA menu. Press "Esc" a second time to return to the EDIT TEST screen and press "Esc" a third and fourth time to return to the top of the MEMRY START menu.

! **SAMPLE SIZE OPTIONS**

This feature enters an optimum sample size and the acceptable minimum and maximum sample range. Sample size ranges can be programmed from 2 grams to 39 grams.

The sample size should be fairly consistent for all tests on a particular product in order to get the best standard deviation possible. When the values for the optimum sample size and the minimum and maximum range are set, an audible "beep" can be programmed to indicate when the sample is too small or too large as it is being loaded.

These values are also used in the horizontal weight scale that is displayed when sample is being added. Use the SAMPLE SIZE OPTIONS menu to program this feature.

To program this information, select SAMPLE SIZE OPTIONS and press the key labeled "Selct." To enter or change an optimum sample size select SAMPLE

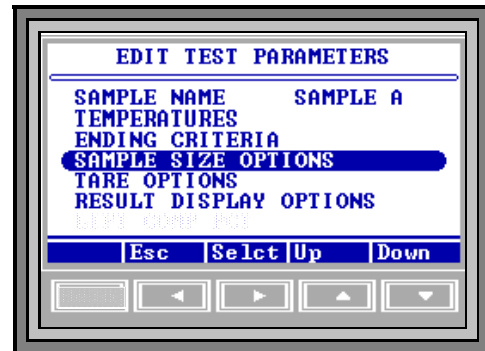

**Figure 27** SAMPLE SIZE OPTIONS

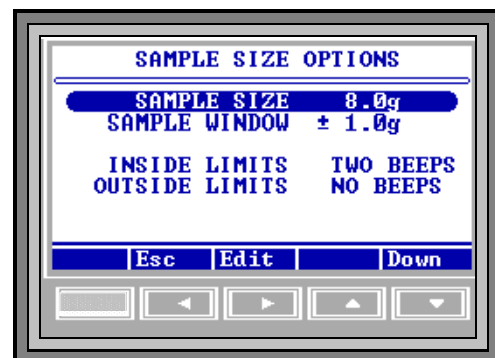
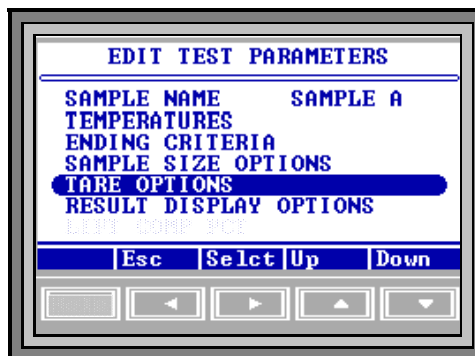

**Figure 28** SAMPLE SIZE

SIZE and press the key marked “Edit.” Press the “Incr” or “Decr” key to change the value. When the desired value is displayed, press the “Acpt” key to record the change or “Cancel” to cancel the change and revert to the previously stored value. Next, enter the SAMPLE WINDOW following this same procedure. Finally, select none, one or two beeps to sound when sample size is within the programmed range. High volatile materials, such as coatings, typically require smaller sample sizes (one to four grams). Low moisture materials, such as low moisture resins, typically require sample sizes from 20 to 30 grams. Contact your sales representative or AZI Customer Service for appropriate sample sizes.

## ! TARE OPTIONS

This screen selects the parameters that define how stable the balance must be before a test will start. There are two menus available under this option to allow better control of tare measurements under different conditions. PAN TARE OPTIONS allow checks that ensure the drift in the measured weight of the empty pan is less than a given number. SAMPLE TARE OPTIONS allow testing to begin after a given tare time has elapsed.



**Figure 29** TARE OPTIONS

### ► Pan Tare Options

Pan tare refers to the first step in a moisture test, the taring of an empty sample pan. Depending on a number of different criteria, such as previous test setpoint temperature, the amount of cool down time between tests, and the current idle temperature, temperature fluctuation across the balance can occur. The temperature fluctuation causes the balance to drift during and after the sample pan tare. The drift is reflected as error in the final moisture number. Since the conditions which cause the temperature fluctuation across the balance are not always constant, this error often appears as a higher standard deviation for a series of tests on a particular sample.



**Figure 30** PAN TARE OPTIONS

The PAN TARE OPTIONS offers the user three mutually exclusive selections to adjust the relationship between tare-time and tare-error to improve overall operation for a given product or purpose. The next table summarizes the menu choices and the parameters associated with each choice.

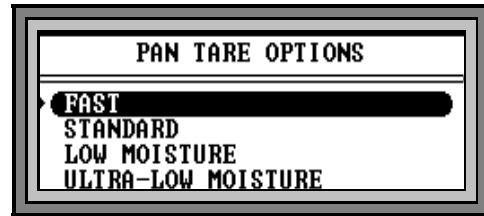

**Figure 31** FAST SELECT

<b>MENU CHOICE</b>	<b>INITIAL TARE TIME</b>	<b>POTENTIAL DRIFT ERROR</b>	<b>POTENTIAL TARE TIME</b>
<b>FAST</b>	<b>6 seconds</b>	<b>up to 20 mg</b>	<b>6 seconds</b>
<b>STANDARD</b>	<b>6 seconds</b>	<b>1.0 to 2.0 mg</b>	<b>UP to 60 seconds</b>
<b>LOW MOISTURE</b>	<b>18 seconds</b>	<b>less than 1.0 mg</b>	<b>UP to 2 minutes</b>
<b>ULTRA-LOW MOISTURE</b>	<b>30 seconds</b>	<b>less than 0.3 mg</b>	<b>UP to 3 minutes</b>

The FAST tare option, as the name implies, is the fastest. If this option is selected, the MAX-1000 zeros the balance, waits six seconds, and records the balance reading as tare weight. There is no check for balance drift. This could cause the ending error to be as great as 20 milligrams. The standard, low moisture and ultra-low moisture options do check for balance drift caused by temperature changes and offer greater accuracy but at increased tare times. In these three options, the pan tare algorithm checks to ensure the balance has drifted less than 0.3mg during a variable TARE TIME (a few seconds to several minutes). For example, a pan tare using the ULTRA-LOW MOISTURE option checks to ensure that the balance has drifted less than 0.3mg in the preceding 30 seconds since the tare command was issued to the balance. This requires that the balance be tracked for the initial 30 seconds. If the drift is excessive at the end of that time, the balance is rechecked every six seconds, and the value is compared against the previous 30 seconds of data until the 0.3mg criteria is met. Depending upon the situation, an ultra-low moisture tare can take as long as four minutes.

The ULTRA-LOW MOISTURE option should be used for samples with a moisture content between 0.005 and 0.2 percent. This option may be used to improve accuracy for samples with a moisture content in excess of 0.2 percent but will increase the overall testing time.

When the tare criteria has been successfully met, the balance is re-tared to zero and the unit beeps to indicate that the it is ready for the sample to be loaded.

To select a PAN TARE OPTION, move the highlight bar to the desired choice and press the “Selct” key. To store the new selection press the “Esc” key.

► Sample Tare Option

There are five possible choices under this menu. The factory default and the most common selection is START WHEN STABLE.

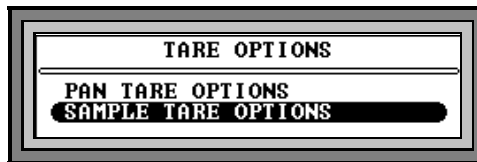

Figure 32 SAMPLE TARE OPTION

START WHEN STABLE:

The balance will start to tare after two seconds. Tare is complete and the test will begin when the balance is stable. The balance is stable when there is less than  $\pm 0.2\text{mg}$  difference in the weight measured on successive weight readings.

Four other tare options are available. These are used with volatile samples or when the instrument is in an unstable environment (with excessive vibrations, for example). These options are:

START AFTER 3 SECOND TARE:

Test starts after three seconds of averaging. (Used for sample materials containing volatile substances such as solvents, which may volatilize during the taring process.)

START AFTER 5 SECOND TARE:

Test starts after five seconds of averaging.

START AFTER 8 SECOND TARE:

Test starts after a three second delay and eight seconds of averaging.

START AFTER 20 SECOND TARE:

Test starts after a three second delay and twenty seconds of averaging.

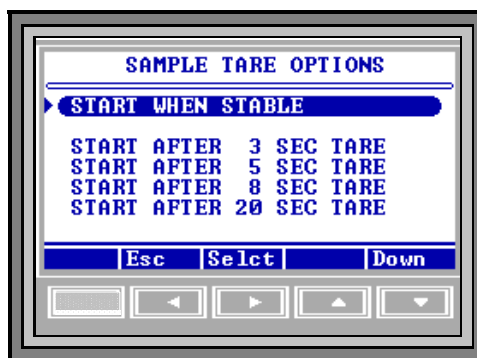

Figure 33 START WHEN STABLE

To change the SAMPLE TARE OPTION, move the highlight bar to one of the four options and press the “Selct” key. To store the new value, press the “Esc” key.

## ! RESULT DISPLAY OPTIONS

Test results can be displayed as a percentage of weight lost during the test (Moisture), percentage weight remaining after the test (Solids), or as a dry weight (Dry Wt) basis value. Dry weight basis is the weight loss divided by the weight remaining at the end of the test. Note that the dry weight value ratio can exceed unity (one), and often does in certain applications such as soil and paper. To program in the desired results, "Selct" the RESULT DISPLAY OPTIONS and toggle through the options until the correct one is displayed. Use the "Quit" and "Esc" keys to save and leave the menu.

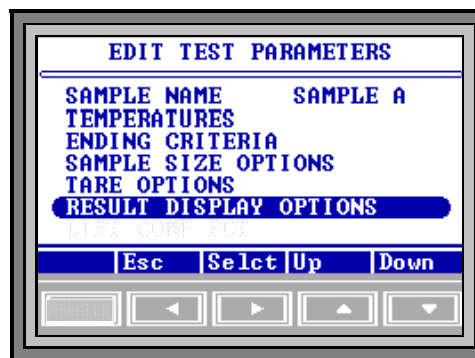

Figure 34 RESULT DISPLAY OPTIONS

### 7.2.2 REORDER MEMORY START

This copies a stored parameter set to another position in the list. If you copy a set over an existing set, the old set is written over and cannot be recovered. Be careful! To quickly create a new set similar to an old one, use REORDER to copy the old one to a blank location, then use ADD/EDIT to enter the new name and changed values.

### 7.2.3 DELETE MEMORY START

This command removes a stored set of parameters. Remember to use this carefully as the information can not be retrieved. The weight and tartrate tests are not affected by this option.

### 7.2.4 PRINT MEMORY START

This command prints the stored parameters. All 7 (00 to 07) of the numbered Memory Start Sets are printed, giving the values of the parameters shown below in the print out example.

#### COMPUTRAC MAX1000 MEMORY START REPORT

#	ID	TST	IDL	HST	SSZ	SWN	MODE	RY	RATE
00	WEIGHT	105	025	025	8.0	1.0	PRED		1.00
01	TARTRATE	150	100	025	8.0	1.0	RATE		0.03
02	TEST	120	050	025	5.0	1.0	PRED	00	
03		090	050	025	3.0	1.0	PRED	00	
04		145	050	025	2.0	1.0	PRED	00	
05		125	050	025	2.0	1.0	RATE		1.10
06	CUSTOM	160	025	025	8.0	1.0	PRED	00	

The column headings are abbreviations for the following:

#	ID number of the Memory Start Set.
ID	ID Name of the Memory Start Set.
TST	Programmed Test Temperature Parameter.
IDL	Programmed Idle Test Temperature Parameter
HST	Programmed HISTART Temperature Parameter.
SSZ	Sample Size
SWN	Sample Window
MODE	Selected End Test On Criteria (Prediction, Rate, or Time)
RY	Reliability Percentage Parameter for End Test on Manual Prediction.
RATE	Rate of Weight Loss Parameter for End Test on Rate.

## 7.3 STORED DATA

---

This function is used to work with data stored in the instrument from past moisture determinations. To access this function, go to the MENU and select STORED DATA MENU.

### 7.3.1 VIEW STORED DATA

This function is used to view a list of all stored test results. The list is presented in abbreviated form consisting of the memory start number used, the sample name, date, and the final result. Pressing “Selct” displays the targeted stability, reliability, tare and rate if they have been selected in the REPORT ITEMS TO PRINT menu, page 40. Moving the selector bar to a particular test and pressing “Selct” changes the screen to a display of the entire stored test result.

### 7.3.2 PRINT STORED DATA

Stored data can be printed to a parallel printer attached to the MAX-1000 (see page 18). That same data can also be routed to a computer (page 20).

To print stored data, select that option on the STORED DATA MENU and press the “Selct” key.



Figure 35 STORED DATA

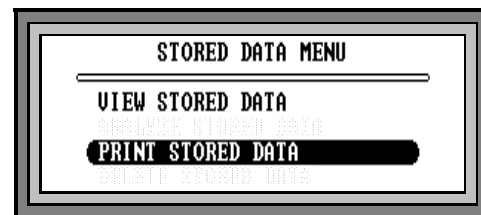

Figure 36 PRINT STORED DATA

## 7.4 CALIBRATION MENU

### 7.4.1 CALIBRATE BALANCE

This process will span calibrate the balance. The balance should be calibrated once per month, whenever the instrument is moved, or whenever a problem is suspected. Calibration requires a clean, dry sample pan, and a 20 gram calibration mass. The screen prompts you to have both available before beginning the calibration process.



Figure 37 BALANCE CAL

! Best results are obtained if the MAX-1000 has been powered up for at least 30 minutes and with the chamber at **room temperature** stabilized at 80°C. A vibration-free table will speed the calibration process, since the balance will stabilize more quickly if it is not subject to vibration.

! To calibrate, “Selct” BALANCE CALIBRATION” and follow the menu prompts on the display.

! Press the down arrow to begin the calibration procedure.

! The first prompt is to OPEN THE LID.

! After placing a clean pan on the scale and closing the door, the screen will indicate that the unit is taring.

! As soon as the tare is finished, the next OPEN THE LID prompt will appear.

! As the lid is opened, the screen prompt requests that a 20 gram calibration weight be placed gently on the center of the sample pan. Do not press down on the scale but just place the weight on the pan.

! With the 20 gram weight in place, gently close the lid.



Figure 38 OPEN THE LID



Figure 39 BALANCE CAL CON'T.

- ! As the MAX-1000 calibrates itself, the screen displays the CALIBRATING -- PLEASE WAIT message.
- ! For best results, the unit should not be moved, jarred, or otherwise disturbed in any way during this calibration time.
- ! As soon as the calibration is complete, the screen prompt asks that the 20 gram weight be removed. If the weight is recorded as  $-20.000 \pm 0.003$  mg, the calibration passed and the MAX-1000 is ready for use. If the weight is recorded out of this range, then the calibration is unsuccessful. In this case, rerun the calibration. If the calibration fails again, then contact AZI Customer Service, (800) 235-3360 or (602) 470-1414.

## 7.5 SETUP MENU

---

The SETUP MENU is used to program the MAX-1000 with information relevant to all operations and test. (To change parameters specific for an application see the section on the “Param” key (page 45) or on the MEMORY START MENU (page 25). To enter the SETUP MENU, select that selection on the MAIN MENU and press the “Select” key.



**Figure 40** SETUP MENU

The next screen shown is the SETUP MENU.

From the SETUP MENU it is possible to change the printer setup, set the clock, change the access codes, customize the data screen, and enter or edit a company name. The first option is PRINTER SETUP.



**Figure 41** PRINTER SETUP

### 7.5.1 PRINTER SETUP

This function is used to inform the instrument of the type of printer

connected (IBM or Epson). Select the type of printer you have by pressing the “Edit” key.

The same key will now be the “Incr” key. Press it to change the displayed name from IBM to EPSON.

If the display is EPSON, Press the “Decr” key to change the displayed name to IBM. When the correct printer name is displayed, press the “Acpt” key. If you are not sure of the type of printer you have see your printer user's manual or contact AZI Customer Service.

The output port is selected in the same way. First move the selector bar to OUTPUT PORT and press the “Edit” key. Then “Incr,” or “Decr” until the correct selection is displayed.

Move the select bar to AUTO FORM FEED and press the “Toggle” key, to select between OFF and ON. If AUTO FORM FEED is selected, the printer will advance to the top of the next page (do a page eject) after each report. When the correct selection is displayed, press the “Esc” key two times to return to the OPENING MENU.

## 7.5.2 REPORT SETUP

This menu allows for the program settings related to the final printout of a test. It is in this menu that the printer is enabled and the printout is customized to your needs.

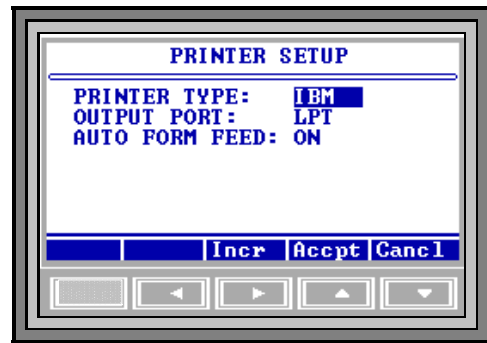

Figure 42 PRINTER TYPE

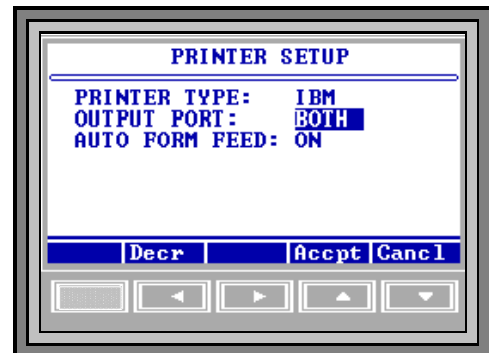

Figure 43 OUTPUT PORT

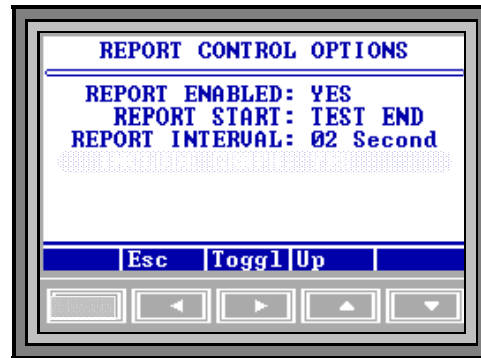

Figure 44 REPORT ENABLED

## ! REPORT CONTROL OPTIONS

This screen controls output to the printer and the RS-232 port. It also controls how often the instrument sends data.

To select this option, move the selector bar in the SETUP REPORT to REPORT CONTROL OPTIONS, then press a key labeled "Selct." This begins the report control change process. The selector bar will be positioned on the last option changed. To change this option, press "Edit" or "Toggle," or to change a different option, move the selector bar to it and press "Edit." The available REPORT CONTROL OPTIONS are:



**Figure 45** REPORT CONTROL

REPORT ENABLED: YES or NO.

REPORT START: START TEST, 1st PRED (first prediction), or TEST END. If TEST END is selected, real time data will not be printed during the test.

REPORT INTERVAL: Minimum of 02 seconds to the maximum of 99 seconds.

To store the new values: Press "Esc."

## ! REPORT ITEMS TO PRINT

The MAX-1000 can store the most recent test result in memory. These test result is available for printing. To change the stored items, select REPORT ITEMS TO PRINT and press the "Selct" key.

The options available on the REPORT ITEMS TO PRINT screen are:

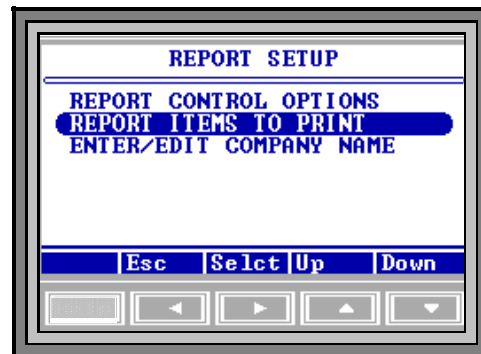

**Figure 46** ITEMS TO PRINT

MEMORY SELCT: Number of the memory start parameter set in effect for this test.

SAMPLE NAME: Identification tag for the parameter set used.

LOT NUMBER: Identification tag for the lot of material to be tested now.

PRODUCT ID: Identification tag for the product in this lot of tested material. Lot number and product ID are alphanumeric

tags entered by the operator to identify a test, or set of tests, for reporting purposes.

DATE:	Date of the test.
TIME OF DAY:	Time of the test.
FINAL RESULT:	Test result value.
RESULT TYPE:	Moisture, solids or dry weight basis.
TEST MODE:	Ending criteria used for this test.
START WT:	Sample basis weight.
END WT:	Sample weight at the end of the test.
TEST TIME:	Minutes and seconds the test was in progress.
START TEMP:	Temperature of the chamber when the test started.
TEST TEMP:	Test setpoint temperature.
HISTART TEMP:	HiStart temperature setpoint.
PAN TARE:	Pan tare setting.
SAMPLE TARE:	Sample tare setting.
SAMPLE CENTER:	Nominal load weight.
SAMPLE WINDOW:	Acceptable load weight.
END REL:	Reliability ending criterion value at the end of the test.
REL TGT:	Target reliability used for PREDICTION ending criteria.
END STAB:	Stability ending criterion value at the end of the test.
STAB TGT:	Target stability used for PREDICTION ending criteria.
END RATE:	Rate ending criterion value at the end of the test.
RATE TGT:	Target rate used for RATE ending criteria.

To change any of the optional items, move the selector bar to the item wanted. To change the option, press the key marked "Toggle." When finished, press the key marked "Esc." The new selections are now stored in the system.

#### ! ENTER/EDIT COMPANY NAME

This function allows report headers to be customized, to show the name of the test location, or other alphanumeric material. The default value is ARIZONA INSTRUMENT CORP.

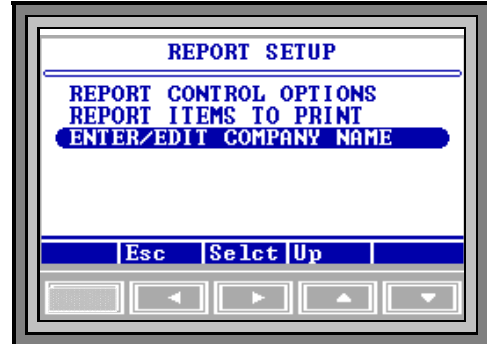

Figure 47 ENTER/EDIT CO. NAME

Once this option has been selected, the left, right, up and down arrows are used to position the cursor and change the letters or numbers. The alphanumeric label contains up to 22 positions and can be changed with the arrow keys. Pressing "Incr" starts at "A" and continues through the alphabet, the numbers, then the symbols. "Decr" starts at the bottom, displaying the symbols first, etc. Select the item to be edited with the up and down arrow keys, and press "Edit." Press "Quit" when editing is complete

### 7.5.3 CLOCK SETUP

This function is used to enter the correct date and time into the clock system. The internal battery saves the clock value and function when the power is off. This function should only be required if the internal battery is replaced.

Use this function to change the time at initial setup, when changing for daylight savings time or when the internal battery is replaced.

If the clock resets (all memory, in fact) whenever the power is off, the internal backup battery may need replacement. If this happens, call AZI Customer Service.



Figure 48 CLOCK SETUP

### 7.5.4 DATA FORMAT SETUP

#### ! ENDING CRITERIA DISPLAY

This process controls the display of the PREDICTED END POINT and the ENDING CRITERIA on the FINAL TEST screen during the test.. Display of these values is useful during parameter development, to aid in selecting the best ending criteria to use for a particular test material. These values serve little purpose, however, during normal operation and may even cause confusion.

#### ! LOT NUMBER AND PRODUCT ID

If the LOT NUMBER function is toggled ON in the DATA FORMAT SETUP menu, then starting a material test will bring up a screen labeled EDIT LOT AND I.D. NUMBER. The alphanumeric label contains up to 10 positions and can be changed with the arrow keys. Pressing “Incr” starts at "A" and continues through the alphabet, the numbers, then the symbols. “Decr” starts at the bottom, displaying the symbols first, etc. Select the item to be edited with the up and down arrow keys, and press “Edit.” Press “Quit” when editing is complete. Press “Acct” to record the change or “Cancel” to leave it unchanged. This function will enable the instrument to retain and report the additional information entered.

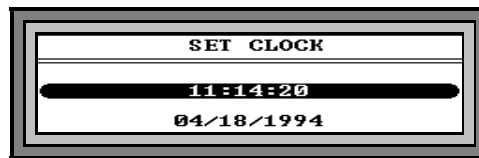
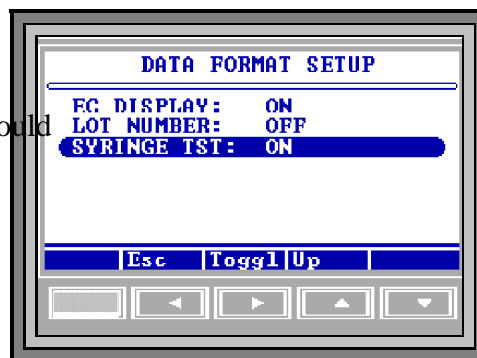

Figure 49 SET CLOCK

## ! SYRINGE TEST

This function is useful when testing materials with high solvent or volatile content. The purpose is to account for the weight loss of material that normally would evaporate during the sample loading process. By weighing the material in the syringe before and after loading, a more accurate start weight can be entered. An external balance with 0.1 mg resolution is required for this function.

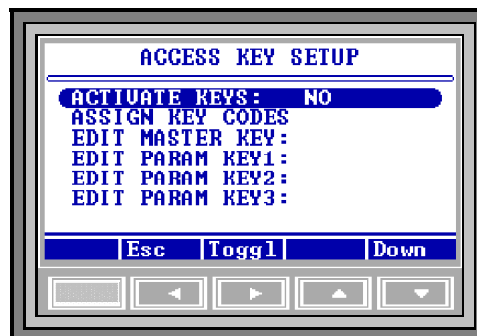

**Figure 50** SYRINGE TEST

To run a syringe test, highlight SYRINGE TEST in the DATA FORMAT SETUP menu, and toggle to ON. Return to FINAL TEST screen and press "START" to run a test as you normally would. REMEMBER TO RECORD THE WEIGHT OF THE SYRINGE WITH THE SAMPLE IMMEDIATELY BEFORE LOADING. Load the sample onto the sample pan and immediately re-weigh the syringe. The instrument will ask you to enter this weight as a new start weight at the conclusion of the test. If you have forgotten to record the manual start weight, the instrument will provide results based upon its normal automatic weighing feature.

### 7.5.5 ACCESS KEY SETUP

The MAX-2000 provides the customer with the ability to enter access codes to prevent unauthorized user's entry into any menu where data can be edited, modified or deleted. All information menus can be accessed, viewed and printed by any user. To enable this option, select ACCESS KEY SETUP in the SETUP MENU. Once in the ACCESS KEY SETUP MENU, highlight ACTIVATE KEYS and toggle yes.



**Figure 51** ACCESS KEY SETUP

A master key code permits access to all menus whether they are controlled by individual key codes or not. If the master key code is forgotten, call AZI Customer Service at 800-235-3360 or 602-470-1414. To enter or edit the master key code, highlight EDIT MASTER KEY and press Edit. Use the arrow keys to create or edit a master key code of up to eight characters.

In addition to a master key, the system allows for three parameter keys to be entered. Each parameter key will allow selected users to access or edit information in select memory starts. These codes are entered and edited in the same way as the master code. Assign parameter key codes to their respective memory starts by highlighting ASSIGN KEY CODES and using the arrow keys to enter a key code.

## 8 “PARAM” KEY: TEMPORARILY CHANGING TEST PARAMETERS

---

To develop a new application, a few tests are run with different values for parameters such as temperature and sample size. Ending criteria and sample size are also changed to improve speed and accuracy. To speed this process, the Param function allows immediate alteration of a test parameter and immediate execution of a test from the parameter change screen. This parameter change function is only available for the parameter set stored in Memory Start 06, entitled CUSTOM.

To quickly change a parameter, press Param at the FINAL TEST screen. If the access code control system is enabled, pressing the “Param” key will bring up a message asking for the access code. Successfully entering the correct code will then bring up the PARAMETERS MENU START screen. Press the large “START” key any time to begin a test with the altered parameter values.



Figure 52 PARAMETER MENU

Details on how to change any parameter can be found in the MEMORY START MENU section beginning on page 25. One example, changing the temperature setpoint, is given below.

### 8.1 CHANGING THE TEMPERATURE SETPOINT

---

- 8.1.1 Temperature is one of the parameters changed most often. To change the temperature setpoint from the MAIN MENU, press the “Param” (down arrow) key. Enter the access code, if requested. Successfully entering the correct code will then bring up the PARAMETERS MENU START window.
- 8.1.2 Move the selector bar to TEMPERATURES with the arrow keys, and press “Selct.” The next window, with TEMPERATURES at the top, lists the three options. Use the arrow keys to change the TEST TEMPERATURE setpoint to the desired value. Move the cursor off the end of the temperature value by pressing “Quit” to complete the process, and press “Acpt” to record the new value. Press “Esc” to return to the previous menu.
- 8.1.3 See the section on TEMPERATURES on page 26 for more details on changing the other OPTIONS on this screen.

8.1.4 The word **START** in the title means that “**START**” can be pressed while in this menu, and the test will begin using the parameters as they have been altered by the user. This parameter set is automatically saved under the title **CUSTOM** in the Memory Start list. (See the section entitled **MEMORY START MENU** on page 25.)

## 9 MISCELLANEOUS MENU MESSAGES

---

### 9.1 CONTROL PROGRAM VERSION NUMBER

---

For troubleshooting purposes, AZI Customer Service may need to know the version (or revision) of the control program running in your instrument. To display this information, turn the power off, wait a second, and turn it on again. Observe the front panel. The program version number will be displayed in the lower center portion of the screen while the AZI logo is displayed.

### 9.2 DIAGNOSTIC FAILURE MESSAGES

---

The MAX-1000 contains extensive diagnostic software, which monitors the performance of the instrument. If a dangerous or abnormal condition is detected, the instrument turns off power to the heater, ends operations, locks the keyboard and displays the following message:

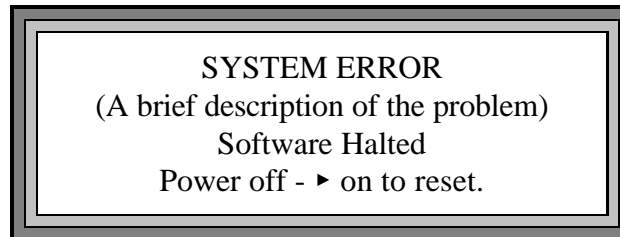

If cycling the power switch does not clear the error, stop using the instrument and call AZI Customer Service (800) 235-3360 or (602) 470-1414.

# 10 PERFORMANCE ENHANCEMENT

## 10.1 INTRODUCTION

10.1.1 The MAX loss-on-drying moisture analysis system takes advantage of computer technology to reduce test times and increase precision over standard vacuum oven or convection oven drying procedures. The sample is added to an aluminum sample pan sitting atop an electronic force balance within a test chamber. As the sample heats and loses weight due to moisture evaporation, the balance records that weight loss and transmits the data to the microprocessor. The microprocessor interprets the information and compares the sample's weight loss to a standard drying curve. The final moisture concentration is extrapolated from the curve and results are available within minutes.

10.1.2 A typical drying curve (see **Figure 53** below) consists of three portions: The first portion (A-B) represents the sample's weight loss as it heats from room to testing temperature.

10.1.3 Section B-C is linear, representing moisture loss from the interior of each particle of the tested sample. The final portion of the curve (C-D) is exponential in nature and represents the final evolution of moisture from within the particle. The point at which no additional weight loss occurs represents the complete evolution of water from the original sample (E).

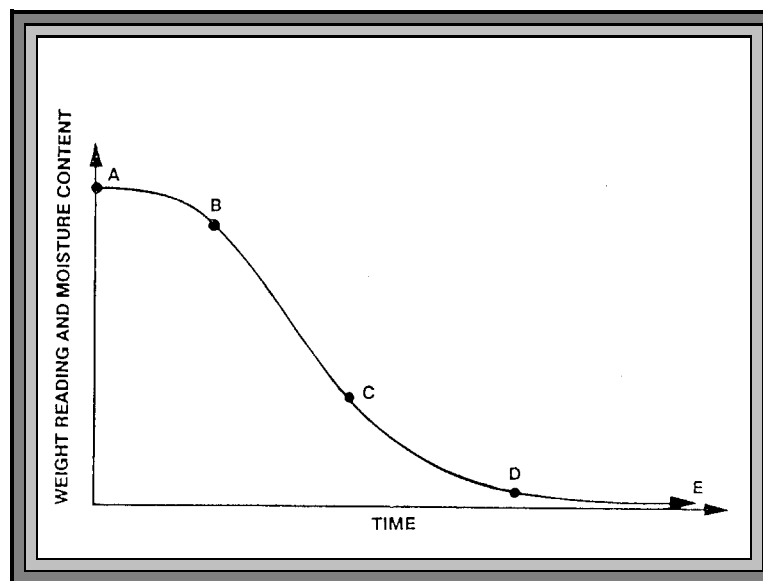

**Figure 53** DRYING CURVE

- 10.1.4 The final portion of the curve (D-E) is the longest and most time-consuming portion of the entire testing process. The time for a sample to reach zero residual moisture can take from one to 24 hours depending upon the sample, sample preparation, and testing temperature. The MAX-1000 loss-on-drying system calculates the sample's moisture concentration through mathematical extrapolation from the exponential (C-D) portion of the curve.
- 10.1.5 Normally, 1 gram to 10 grams of sample are placed on an aluminum sample pan in the test chamber. (Range can be 150 milligrams to 40 grams.) The aluminum pan sits on a pan support coupled to a sensitive digital electronic force balance. The force balance registers the initial weight of the sample before testing and relays the sample's decreasing weight to the microprocessor for evaluation. Balance readings are averaged to eliminate signal interference or erroneous data.
- 10.1.6 Test temperatures can be programmed between ambient (25°C) and 225°C in either a one or two-step temperature contour. Heating is done through a 700-watt nichrome element, which is located on the underside of the test chamber's lid. An RTD monitors the temperature of the test chamber and sends that information back to the microprocessor. Under the microprocessor's control, the heater element is cycled on and off to bring the test chamber to the programmed level. The temperature is maintained within 1°C of the programmed temperature throughout the test.
- 10.1.7 A unique HISTART mode (see HISTART TEMPERATURE) on the MAX-1000 takes advantage of the evaporative cooling effect at higher temperatures to reduce test times and improve repeatability. When the HISTART mode is used, each cycle begins with a higher temperature setting to rapidly evaporate moisture from the sample. The cooling effect of surface evaporation prevents burning of the sample although the chamber temperature may be quite high. During this high temperature period, the sample's weight loss is closely monitored to detect when the evaporation rate has decreased to a point where the cooling effect is lost. To prevent sample burning, the unit drops the temperature to the lower setting for slower drying. The higher beginning test temperature speeds the sample through the A-C portion of the drying curve. The lower ending temperature takes the sample through the exponential portion (C-D) of the curve where an accurate prediction of the moisture concentration can be made. See the section on HISTART TEMPERATURE page 54, for procedures on determining the ideal temperatures. Page 27 gives information on programming these values into the MAX-1000.

- 10.1.8 During the entire testing process the microprocessor monitors the sample's weight loss. The sample's decreasing weight is compared to the initial sample weight and the calculated moisture concentration will appear on the display. Simultaneously, the microprocessor is predicting a final moisture concentration based upon the sample's rate of weight loss compared to the exponential portion of a standard drying curve. Testing will continue until the predicted moisture concentration agrees within a certain percentage of the actual moisture concentration appearing on the display. The percent agreement between the predicted and the actual moisture concentrations will vary depending upon the system's programming and the moisture level of the sample.
- 10.1.9 The MAX-1000 is an extremely flexible instrument. This flexibility means that some time is required to determine the best set of parameters for a particular application. The determination of the proper parameters requires a series of tests, and good laboratory procedure. AZI Sales and Customer Service personnel are trained to help in this process. If any questions arise, please call (800) 235-3360 or (602) 470-1414 for assistance.

## **10.2 DETERMINING PROPER TEST TEMPERATURE**

---

- 10.2.1 To decide the proper test temperature for a particular sample, prepare a moisture versus temperature curve. Sample material is tested at increasing temperatures, usually in five or ten degree increments. If the moisture concentration of the sample material is known, as determined by a reference method (vacuum or air oven), then the MAX-1000's temperature can be adjusted until test results correlate with the established moisture concentration.
- 10.2.2 The starting temperature is usually the standard or reference method temperature for that particular sample. Results for each increasing temperature will usually rise to a plateau where several increasing temperatures do not change the results significantly. Beyond this plateau results rise dramatically, (**Figure 54**). Examination of the tested sample shows burning or charring.
- 10.2.3 Results along this plateau usually correlate well with the standard or reference method results. Repeated testing should be done at temperatures in this range. Several tests are performed using the same sample size and test parameters. Results from these repeated tests are tabulated to calculate the mean, or average, and the standard deviation (S.D.). Analysis of the mean and standard deviation, and their comparison with reference method results, determines that the proper test temperature has been used. If mean values do not compare well, or if the standard deviation is too large, test at another temperature along the plateau.

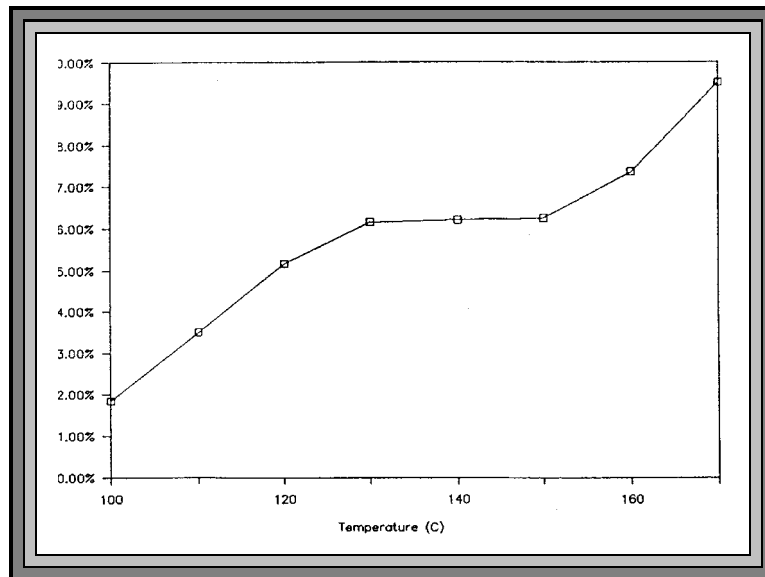

**Figure 54** MOISTURE VS. TEMPERATURE CURVE

### **10.3 SELECTION OF ENDING CRITERIA**

---

- 10.3.1 The MAX-1000 uses a sample dependent test to end a test when END TEST ON PREDICTION is selected. The prediction uses a test called the reliability criterion which is equal to one minus the ratio between the "actual weight loss" at a given moment, and the end point predicted by the microprocessor. This parameter can be set to TIGHT, MIDRANGE, or RELAXED depending on the user's desire to balance speed and accuracy.
- 10.3.2 The END TEST ON RATE criteria will cause the test to end when the sample weight loss rate has fallen below a threshold value. This is useful for samples that do not conform to the standard exponential drying model.
- 10.3.3 The decision of which ending criteria to use is application dependant. Experiment with your particular sample to determine which criteria is best for your product. See the earlier section on ENDING CRITERIA, page 29, or Appendix A or B for more details.

# 11 SAMPLE PREPARATION, TESTING AND ANALYSIS

---

## 11.1 SAMPLE PREPARATION

---

- 11.1.1 The MAX system can be used to test a wide range of products from finely ground, low-moisture powders to high-moisture slurries. **For best results, the sample should be of a uniform particle size and homogeneous in nature.** Large chunk samples, such as charcoal or cookies, should be crushed or ground to smaller pieces approximately 1/4" or less in diameter. Some samples, such as dried vegetables, may also need to be ground. The smaller pieces will easily release moisture during testing, leading to shorter test times and more repeatable results.
- 11.1.2 Any sample tested for moisture should be as uniform as possible. If sample material is collected into a jar or sampling bag, shake the jar or bag to produce a uniform mixture. Liquid samples should also be mixed or shaken to ensure a more homogeneous mixture.
- 11.1.3 Solid, granular sample material should be shaken onto the pan from a spoon; shaking sample directly from the collection jar will usually deposit only the larger granules, not a representative mixture. Liquid samples or slurries can be spooned or poured onto the sample pan; however, a pipette or sampling straw will collect a more homogeneous mixture of sample.

## 11.2 OPTIMUM SAMPLE SIZE

---

- 11.2.1 Each particular sample will have its own optimum sample size. Best results will be obtained if the sample consists of a single layer of particles, as long as this is sufficient to develop a weight loss of 10 milligrams or more. A rule of thumb is "the lower the moisture, the larger the sample." Low-moisture samples (less than 0.100%), such as chemicals or plastics, require larger amounts of sample (20 to 30 grams). The larger sample size is necessary to provide sufficient weight-loss information to the microprocessor. A larger weight change between the initial and final sample weights will give more accurate, repeatable results. Smaller samples will give faster tests. Generally, it is best to use a thin layer that just covers the surface of the pan. Very light, or very expensive test materials may require samples weighing as little as 100 milligrams. Be aware that the standard error will be larger for samples this small, unless the moisture content is sufficient to cause a weight change of 10 milligrams or more for each test. If the first prediction is too low, increase sample size. If it is too high, try decreasing sample size, or lowering the temperature.

11.2.2 The sample should be added evenly, in a thin layer, across the entire surface of the pan. Once the desired amount has been added, the pan can be removed from the test chamber to evenly distribute the sample. The sample should be distributed over the surface by gentle shaking, tapping, or for very viscous samples, spread with a spoon or knife. Do not spread granular products with a spoon as the particles compress even under gentle pressure, affecting test times and results. An even layer of sample across the pan will reduce test times and increase precision of results.

### **11.3 LIQUID SAMPLES**

---

11.3.1 Some liquid samples will dry slowly, even at high temperatures. Drops or puddles may form on the pan that dry slowly as the sample concentrates. A skin may form which limits evaporation from the interior. Long test times (greater than 25 minutes) and low % moisture (or high % solids values) suggest incomplete drying. Pre-dried glass-fiber filter paper and flat bottomed pans are recommended to successfully test samples such as these.

11.3.2 Filter paper serves as a support for the liquid sample. The sample is absorbed through the paper where a more even, rapid evaporation occurs, reducing test times.

11.3.3 Occasionally, some samples cannot be absorbed into the filter paper. At the end of the test, examination of the sample pan shows the sample sitting high above the filter paper with a thick crust. The crust may be singed from the heat or even show bubbling where vapor has collected beneath the surface. % SOLIDS results will be high or % MOISTURE results will be low. Samples such as these are treated differently: After the sample has been added to the sample pan, remove the pan from the test chamber and place it onto a flat surface. Grasp part of the filter paper (tweezers are suggested) and flip it over so that the sample lies between the pan and the paper. Squash the sample with a flat-bottomed glass or jar to a uniform layer. Return the sample pan to the test chamber and close the lid. The upper filter paper surface absorbs moisture from the sample and prevents spattering to produce more accurate, reproducible results.

11.3.4 The glass-fiber filter paper may be pre-dried before use in some applications. Several sheets can be dried in a MAX-1000. (Test at 150°C with the END TEST ON PREDICTION). After drying, store the filter paper in a desiccator to prevent the absorption of ambient humidity. Waffle-bottomed sample pans are **not** recommended for use with filter paper. The liquid sample may soak through the filter paper and collect in puddles in the pan's depressions. Contact AZI Customer Service to order flat-bottom pans, (AZI part number 990-0010).

## **11.4 SPEED VS ACCURACY**

---

- 11.4.1 The shortest possible test time using automatic (prediction based) ending criteria is one minute. This is a result of the time required to compute the prediction. Normally, if the sample size is optimum, and no interfering volatiles are present, two minute tests produce optimum accuracy.

## **11.5 HIGH START TEMPERATURE SELECTION**

---

- 11.5.1 Once the base start temperature has been determined, it may be possible to utilize the HISTART feature to speed a test and still obtain accurate results. Experiment with various high start temperatures until one is found that gives the fastest test times without sample degradation. Start 10 degrees above the normal test temperature and work upward in equal increments to find the best combination. If sample degradation occurs, usually indicated by a change in color or transparency, use a lower temperature. It is not normally a good idea to use a high start temperature more than 30°C above the normal temperature.
- 11.5.2 As the HISTART temperature is increased, the test should decrease while final moisture or solids results are within range. Beyond a certain temperature, which is different for different materials, results will go out of range as the sample burns.

## 12 PERFORMANCE VERIFICATION

---

Periodic checks of the system are recommended to verify proper system operation. These periodic checks will satisfy some quality assurance guidelines when performed daily. A log is recommended, either hand written or computer managed, which will record the weight tests, sodium tartrate tests and retained sample's results. Shifts in results that are out of range can be quickly detected and the appropriate corrections made.

Any time the unit is moved, the power is switched off or the balance is jarred or bumped, the 20 gram balance calibration, should be performed (see page 37).

The weight test should be the basis for a daily quality control verification of the MAX-1000 and should be the first test performed every day.

In addition, if there is any concern about the accuracy of the instrument, these same tests may be performed to evaluate instrument performance.

### 12.1 WEIGHT TEST

---

This test simulates moisture content with the removal of one of two known weights. The test is run with specific parameters which are stored under Memory Start 00. See the section on MEMORY START selections on page 23.

- 12.1.1 From The FINAL TEST screen, press the “Memry” key.
- 12.1.2 If the highlight bar is not already there, use the up and down arrows to select **“00 ID: WEIGHT.”**
- 12.1.3 Place a clean, empty sample pan on the pan support.
- 12.1.4 Close the lid and press the “START” key.
- 12.1.5 When the OPEN LID appears on the screen, open the lid and carefully place both a 5 gram and a 3 gram weight near the center of the sample pan.
- 12.1.6 Close the lid.
- 12.1.7 After the testing screen is displayed, gently open the lid and carefully remove the 3 gram weight.
- 12.1.8 Wait for the end of the test.

12.1.9 If this is the first test of the day, discard the results of this test for stability reasons.

12.1.10 Record the final result. The value should fall between 37.48 and 37.52.

12.1.11 If the results do not meet this criteria a weighing error has occurred.

12.1.12 The most common causes of such errors are bent or dirty sample pans, or debris falling into the balance shaft interfering with the pan support's ability to freely move up and down.

12.1.13 After the instrument is cleaned:

! Use a new sample pan and repeat the weight test five more times.

! Calculate the results.

! If the results are still outside the specified range, call AZI Customer Service for assistance.

## **12.2 PRECISION WEIGHT TEST**

---

12.2.1 Run five weight tests and record the results.

12.2.2 The recorded results should fall within the following.

<b>NUMBER OF SAMPLES</b>	<b>5</b>
<b>MEAN</b>	<b>37.48 TO 37.52</b>
<b>STANDARD DEVIATION</b>	<b>LESS THAN 0.01</b>
<b>COEFFICIENT of VARIATION</b>	<b>LESS THAN 0.03%</b>

## **12.3 SODIUM TARTRATE TEST**

---

The sodium tartrate test verifies the heater and force balance operation. Sodium tartrate dehydrate is a chemical with a known moisture concentration which gives up moisture at temperatures greater than 120°C.

Because of its consistent moisture concentration, it is used as a standard in moisture measurement using oven or titration methods. To obtain consistently

reliable results, use a high quality or reagent grade (ACS certified) granular sodium tartrate. Avoid using sodium tartrate that contains lumps or has an uneven consistency since lumps indicate the absorption of ambient humidity and will yield variable results. Sift the sodium tartrate through a #20 sieve to eliminate any lumps or large crystals that pop off the sample pan during the test.

The test uses approximately 8 grams of sample and is run at 150°C. Results should be within a range of  $\pm 0.100\%$  of the assayed value on the label of the chemical. (typically 15.61% - 15.71%)

- 12.3.1 From the FINAL TEST screen, press the “Memry” key.
- 12.3.2 If the highlight bar is not already on it, use the up and down arrows to select **“01 ID: TARTRATE.”**
- 12.3.3 Press the “START” key.
- 12.3.4 When the OPEN LID appears on the screen, open the lid and GENTLY place a new, clean sample pan on the pan support.
- 12.3.5 Close the lid and allow the unit to tare.
- 12.3.6 When the OPEN LID appears on the screen again, open the lid and gently and evenly shake sodium tartrate over the surface of the sample pan until the display shows that 7.9 to 8.1 grams of sample are loaded.
- 12.3.7 Close the lid and the test will begin.
- 12.3.8 Wait for the end of test signal.
- 12.3.9 If this is the first test of the day, discard the results of this test for stability reasons.
- 12.3.10 Results should be within a range of  $\pm 0.100\%$  of the assayed value on the bottle label.

## **12.4 PRECISION TARTRATE TEST**

---

- 12.4.1 Run five sodium tartrate
- 12.4.2 The mean of the sodium tartrate results should be  $\pm 0.10\%$  of the value on the bottle label.
- 12.4.3 If the result is still out of tolerance, The most common causes of such errors are bent or dirty sample pans, or debris falling into the balance shaft, interfering with the pan support’s ability to freely move up and down. Also, clean the heater assembly and check the temperature sensor.
- 12.4.4 Repeat the tartrate test again, using a clean sample pan for each of the five samples, and analyze the results.

12.4.5 If the mean is still out of tolerance, call Arizona Instrument Customer Service for assistance.

## **12.5 RETAINED SAMPLES**

---

The weight test and the sodium tartrate test are usually sufficient to satisfy industry guidelines for quality control in moisture measurement. Some additional checks can be performed using replicate testing of retained samples. Retained samples, when stored under airtight conditions, should maintain moisture levels for long periods. Daily testing of these samples should produce the same results day after day. Retained samples further verify the unit's operation on the customer's own product.

12.5.1 Let the system warm up for 20 minutes.

12.5.2 Set the MAX-1000 to the optimum test temperature for the retained sample or use the ID Number of a test which has been stored in memory.

12.5.3 Place a clean aluminum sample pan onto the pan support in the test chamber.

12.5.4 Close the lid and push the "START" key.

12.5.5 When the OPEN LID display appears, GENTLY add the optimum amount of retained sample evenly across the sample pan.

12.5.6 Close the lid and allow the test to continue.

12.5.7 Record the final result in the quality control log.

12.5.8 The % MOISTURE results for the retained sample should fall within the established acceptable range of results for that sample. If results are out of range, repeat the test to verify results.

## 13 ROUTINE MAINTENANCE

---

The MAX-1000 requires routine cleaning to keep the test chamber free of excess sample material. Failure to keep the instrument interior clean reduces its accuracy and repeatability. Sample material collecting in the test chamber prevents free movement of the pan support. Also, sample material collecting on the heater shroud prevents the lid from closing completely, causing erratic moisture results. Material also falls into the system's interior, causing balance problems. Routine cleaning of the test chamber reduces the possibility of problems and repairs, extending the life of the instrument.

### 13.1 CHAMBER INTERIOR

---

The chamber interior needs to be cleaned daily. To clean the chamber interior, switch the main power switch off. A vacuum line, portable vacuum cleaner, or a small paint brush can be used to remove debris from the chamber.

**CAUTION:** A compressed air line or canned air is **not** recommended, as debris flows into the system's interior and settles in the electronic components.

### 13.2 HEATER CLEANING

---

Testing of some materials may cause a brown discoloration behind the heater and on the inside of the heater shroud. This darkening affects results as heat is absorbed rather than reflected from the heater onto the sample.

It may be necessary to periodically clean this heater. Items needed:

- ! Cleaning solution such as "409" in a spray bottle. \*
- ! Cloth and/or paper towels
- ! Small stiff bristle brush such as toothbrush or acid brush
- ! Cotton swab
- ! Water for cleaning and wiping shroud and heater after cleaning
- ! Small Phillips head screw driver if you elect to remove the shroud
- ! RTD alignment gauge (AZI p/n 360-0164)

\* NOTE: An oven cleaner such as "Easy-Off" should not be used on the aluminum shroud as it is corrosive and will pit the aluminum.

1. Turn the unit off and unplug the Computrac. Ensure the unit has cooled down to ambient temperature. Remove the pan and use the supplied tweezers to pop the pan support up and out of the test chamber. **Be careful - excess force on the**

**balance could result in costly repairs.** Cover the pan support hole in the bottom of the chamber with masking or other similar tape. Carefully mark the RTD with a permanent marker on the inside of the shroud and on the outside of the clamp to mark the relative RTD position in the heater.

2. Remove the shroud to provide the maximum cleaning benefit. Remove the four evenly spaced, small screws, located on the outside of the shroud, holding it in place. Carefully slide the RTD out of the shroud. Take care not to pull the RTD wires out of the heater box while removing the shroud.

3. Lightly spray the shroud with cleaning solution and allow it to stand for several minutes. Scrub with the stiff bristle brush. Repeat if necessary to remove layers of accumulated buildup. Rinse under warm water and dry.

4. Prepare the heater box by placing paper towels around the elements. Lightly spray the front (face) of the heater box and allow to stand, or alternately spray a damp cloth or paper towel with cleaner and clean the heater box. Use a small brush or cotton swab to remove excess buildup. Dry the front of the heater with paper towels or damp cloth until clean.

**Do NOT spray cleaner heavily into the heater and/or shroud area. Excessive moisture could affect wiring and its insulation.**

5. Allow heater box to dry for at least fifteen minutes to ensure that is completely dry.

6. Re-assemble heater and correctly position the RTD using the RTD alignment gauge and the marks made with the permanent marker. If an RTD alignment gauge (AZI p/n 360-0164) was not included with the delivery of your unit, please contact your Sales Representative or Customer Service Representative to obtain one before attempting to clean your instrument.

7. Remove the masking tape from the hole in the chamber floor and carefully install the pan support and pan. Run a weight test to verify that the unit is functioning correctly (see page 55).

Cleaning frequency will vary depending on the application and frequency of use. We recommend that you establish a periodic cleaning schedule to ensure unit to unit correlation and performance. The instrument should be returned to AZI on an annual basis for a temperature calibration which is NIST traceable. Call AZI Customer Service if you have any questions.

### 13.3 SAMPLE PAN SUPPORT

---

The sample pan support should be cleaned periodically if a high volatile material is being tested and condenses on the pan support. **Remove the pan support and balance adaptor carefully and then clean it by wiping with a tissue or paper towel.**

# 14 TROUBLE DIAGNOSIS

---

SYMPTOM	DIAGNOSIS	REMEDY
Answer always zero	Temperature too low No heat Sample too small	Raise setpoint See symptom below Increase sample
Answers vary too much	Sample too small Samples not uniform Sample particles too large	Reduce sample Grind sample Grind sample
Blank display	Contrast controls not set No power  Microprocessor failure Backlight connector disconnected	Adjust contrast Check power cord connections Open front, press reset Reconnect
Heat will not turn off	Set wrong Circuit board failure	Adjust ending criteria Call AZI
Moistures too high	Temperature set too high Bent sample pan Dirty sample pan Debris in balance gaps Dirty heater assembly	Lower temp Use new pan Use new pan Clean Clean heater assembly
Moistures too low	Temperature too low Sample too small Sample too large Sample needs spreading	Increase temp Increase sample Decrease sample Spread
Moisture never stops increasing	Other volatiles Balance drifting	Try lower temperature Run drift check
No heat	Voltage selection wrong  Wiring failure in heater circuit  Heater failure  Door sensor failure  Temperature setpoint too low	Check power module at rear of instrument, set to correct voltage Call AZI Customer Service Call AZI Customer Service Check display for LID OPEN message when open Raise temperature above room ambient or standby temperature

SYMPTOM	DIAGNOSIS	REMEDY
No power to instrument	Fuse blown Power switch off Power cord disconnected  Outlet not powered	Remove and test fuse Check switch position Confirm power cord seating Test circuit with lamp
No weight reading displayed	Balance not initialized	Turn power off, then on, wait 15 seconds
Erratic results	Poor AC ground  Dirt in chamber/pan support	Ensure grounding from case ground to earth ground Clean unit
Display erratic	Unit cold (near freezing)	Allow to warm-up
Unit resets and alarms during a test	Lid open for an extended period of time during test	Turn switch off and on
UNDERLOAD when "START" pressed	Sample pan or pan support not in place	Install pan and/or support, "Quit" test and press "START" again
Instrument won't tare	Test chamber temperature fluctuates/changes Dirt in test chamber or under pan support	Allow system to stabilize  Clean

# 15 TROUBLE MESSAGES

---

Messages appear on the display screen when certain internal problems occur. You will probably never see one of these messages. However, if one should appear, the message and its meaning are provided in the following.

## **BAD EPROM CHECKSUM**

The EPROM is continuously checked against a pre-calculated CHECKSUM to insure against failure. This message appears if a discrepancy is detected.

Probable causes:

Bad EPROM chip.

Action:

Replace U4.

## **SRAM**

SRAM chip is continuously checked for proper operation during program execution. Message generated if error in SRAM detected.

Probable cause:

Bad SRAM chip.

Action:

Replace U3.

## **HEATER RUNAWAY**

Message is generated if the lid is closed and temperature exceeds 290°C for 3 seconds. It is also generated if the lid is open, and the temperature does not decrease according to an exponential model.

Probable causes:

Failed triac or triac driver (probably both). Alarm can sometimes be generated spuriously if ambient conditions prevent normal cooling of the heater when lid is up (wind currents blowing heat back on the RTD).

Action:

Insure actual failure has occurred. If not, reset system. Troubleshoot heat control system.

## **HEATER FAILURE**

Message is generated if the heater does not reach the set temp in a prescribed period of time (varied with set temp based on heater model) or starting test with low test temperature at ambient temperature.

Probable cause:

Failed heat control system.

Action:

Power unit off and back on and attempt second test. Troubleshoot heat control system and/or troubleshoot heater wiring.

## **TEMPERATURE CIRCUIT**

Message is generated if temperature circuit is not detected.

Probable cause:

A-to-D failure. RTD failure. Bridge circuit failure. MPU failure.

Action:

Troubleshoot temperature circuit. Check RTD connection to board.

## **A/D TIMEOUT**

Message generated if A/D does not clear in 100mS.

Probable cause:

Bad A/D. Bad A/D timing circuit.

Action:

Troubleshoot A/D circuit.

## **INTERRUPT STARTUP**

Something caused the system to crash and reset.

Probable cause:

Usually RAM corruption of some kind.

Action:

Troubleshoot system.

## 16 SPECIFICATIONS

---

### Description:

The MAX-1000, an advanced moisture analyzer for the Computrac product line, is a sister unit to the highly featured MAX-2000. The MAX-1000 uses the same convection heating feature and the patented prediction algorithm as the MAX-2000 to quickly and accurately measure moisture levels in a variety of materials. Some features that are available on the MAX-2000 are not available on the MAX-1000. This reduction in features serves to justify a lower list price for the MAX-1000 which is positioned for the low cost, small budget end-user.

The following table describes the MAX-1000 features:

<b>Feature</b>	<b>Specification</b>
Dimensions	<ul style="list-style-type: none"><li>• 235mm H x 300 mm W x 575 mm D</li><li>• 9.5 in H x 12 in W x 24 in D</li></ul>
Weight	<ul style="list-style-type: none"><li>• 13.9 kg</li><li>• 32 lbs.</li></ul>
Casework	<ul style="list-style-type: none"><li>• Per drawing 7200-0244</li></ul>
Power Requirements	<ul style="list-style-type: none"><li>• 110-120 volts 50/60 HZ, 1 amp standby or 6 amps heat on, or</li><li>• 210 - 240 volts 50/60 HZ, 0.5 amp standby or 3 amps heat on</li><li>• Power control and fuses at rear of unit</li></ul>
Heating Range	<ul style="list-style-type: none"><li>• 25° C to 225°C set point in 1°C increments</li><li>• Temperature accurate +/- 1°C</li></ul>
Heater Calibration	<ul style="list-style-type: none"><li>• Factory calibration traceable to NIST</li></ul>
Test Temperatures	<ul style="list-style-type: none"><li>• User-set through temperature range for chamber temperature maintenance, test temperature control and dual test temperature programming</li></ul>
Balance	<ul style="list-style-type: none"><li>• Built in, automatic operation</li></ul>
Sample Size	<ul style="list-style-type: none"><li>• 1 gram to 40 grams</li></ul>
Resolution	<ul style="list-style-type: none"><li>• Moisture - 0.01%</li><li>• Balance 0.001 gram</li></ul>
Balance Calibration	<ul style="list-style-type: none"><li>• Automatic, menu driven, one point calibration at 20 grams</li></ul>
Display	<ul style="list-style-type: none"><li>• 30 character, 9 row LCD with back light display</li></ul>

Feature	Specification
Test Display	<ul style="list-style-type: none"> <li>• Continuous display of test time, current temperature, programmed test temperature, and current sample weight and calculated weight loss.</li> </ul>
Interface	<ul style="list-style-type: none"> <li>• RS-232 (9 pin standard)</li> <li>• Parallel printer (PC standard)</li> </ul>
Moisture Range	<ul style="list-style-type: none"> <li>• 0.10% to 100% moisture</li> </ul>
Repeatability	<ul style="list-style-type: none"> <li>• +/- 0.02% standard deviation, depending upon program</li> </ul>
Firmware	<ul style="list-style-type: none"> <li>• Menu driven through LCD display</li> </ul>
Memory	<ul style="list-style-type: none"> <li>• Storage of last test's results</li> <li>• Storage of up to 5 different test parameters plus 2 quality test programs</li> </ul>
Access Code	<ul style="list-style-type: none"> <li>• Up to four user-selectable codes, up to eight digits in length: 1 master code and 3 individual codes for specific memory start control</li> <li>• One "universal" code for factory use and override</li> </ul>
Results Display	<ul style="list-style-type: none"> <li>• Moisture</li> <li>• Solids</li> <li>• Dry weight</li> </ul>
Ending Criteria	<ul style="list-style-type: none"> <li>• Predict, selectable from "relaxed," "midrange," or "tight."</li> <li>• Rate, from 0.1%/minute to 9.99%/minute</li> </ul>
Programmable Features	<ul style="list-style-type: none"> <li>• Sample name</li> <li>• Lot number or product ID</li> </ul>
Consumables	<ul style="list-style-type: none"> <li>• Aluminum sample pans</li> <li>• Filter paper</li> </ul>
Certifications	<ul style="list-style-type: none"> <li>• UL listing pending</li> <li>• CE certification pending</li> </ul>
Options	<ul style="list-style-type: none"> <li>• Nitrogen purge fitting</li> <li>• Dot matrix printer</li> </ul>
Accessories	<ul style="list-style-type: none"> <li>• 20 g Balance calibration weight</li> <li>• 3g and 5g weights</li> <li>• Tweezers</li> <li>• User's manual</li> <li>• Power cord</li> </ul>

## 17 ACCESSORIES & MAINTENANCE PARTS

---

# MAX-1000 Moisture Analyzer

### Accessories & Maintenance Parts

#### CONSUMABLES

990-0008

990-0010

990-0003

Flat Bottom Sample Pans (100 PCS)

Filter Paper (100 PCS)

#### SPARE PARTS

690-0003

690-0004

690-0007

690-0012

360-0164

170-0014

190-1001

190-1002

200-0002

200-0003

200-0008

200-0021

200-0026

360-0164

300-0106

300-0114

300-0135

300-0129

300-0176

355-0179

355-0073

355-0074

355-0075

355-0079

600-0140

600-0105

990-0044

SS-188

600-0131

3g Weight

5g Weight

20g Weight

Tweezers

RTD Alignment Gauge

Fan

8 Amp Fuse

4 Amp Fuse

Power Cord - IIOV

Power Cord - British Standard - 220V

Power Cord - Continental Europe - 220V

Optical-switch Cable Assembly

RTD Cable Assembly

RTD Alignment Gauge

Inside Shroud Gasket

Outside Shroud Gasket

Keypad

Damper Spring Mandrel

LCD Module

Pan Support

Torsion Spring, RH

Torsion Spring, LH

Mandrel Torsion Spring, RH

Gas Spring

Retrofit Spring Kit

Printer Cable (6')

Printer

MAX-1000 User's Manual

Force Balance; Factory Repair

Waffle Bottom Sample Pans  
(100 PCS)

# 18 APPENDIX A

---

## 18.1 PARAMETER DEVELOPMENT - CHEMICALS INDUSTRY

---

Following are the guidelines for developing parameters.

TEST TEMPERATURE: Adjust as needed

Be sure to use a temperature that is high enough to drive off all the moisture but does not degrade the material in any appreciable way.

If after establishing good accuracy with the material, the test times are longer than desired; then try using HISTART. Start with a HISTART temperature that is 20° C higher than the TEST temperature.

STANDBY TEMPERATURE:

Dry samples	50°C
Water-based solutions	50°C
Solvent-based solutions	50°C

If possible, experiment with a standby temperature of 80°C, especially with those samples using test temperatures greater than 120°C.

ENDING CRITERIA:

If accuracy and/or reproducibility is not acceptable, try working with rate ending criteria. If accuracy and reproducibility is still not acceptable, contact your Sales Representative for assistance.

If possible, when acceptable results are established using either auto or manual predict, work with the material with the rate ending criteria to see if the results can be improved.

SAMPLE SIZE:

SUGGESTED ENDING CRITERIA

SAMPLE TYPE	SIZE	RATE
Dry samples	5-7 grams	0.1%
For moisture levels <0.1%	15-20 grams	0.05%
Water based solutions	1-2 grams	0.2% -0.1%
Solvent based solutions	1-2 grams	0.2% - 0.1%

If test times are too long with water or solvent based solutions, reduce the sample size in 1 gram increments until the desired test time is reached (typically 3-5 minutes).

Begin water and solvent solution sample testing with flat pans.

#### SUGGESTED TECHNIQUES - LIQUID SAMPLES

It is recommended that the pan or the pan w/filter paper (if used) be cooled after the pan tare and before the sample is added. This can be done quickly and easily by removing the pan or pan w/filter paper and fanning back and forth a few times. Apply sample quickly using a syringe or pipette in a spiral motion over the surface of the pan. For extremely volatile samples, use the syringe test procedure. See SYRINGE TEST, page 43.

#### SUGGESTED TECHNIQUES - DRY SAMPLES

Spread sample evenly over the surface of a waffle pan. If desired, you may place the appropriate amount of sample in center of pan. Then remove pan and sample from balance and place on flat surface. Shake the pan to distribute the sample evenly.

#### TARE OPTIONS:

##### Dry samples

Pan tare	Tare Selection
If moisture is < 1%	Low moisture
If moisture is < 0.1%	Ultra-low moisture
Sample tare	When stable (3 seconds)

##### Water-based solutions

Pan tare	Low moisture
Sample tare	3 seconds

##### Solvent-based solutions

Pan tare	Low moisture
Sample tare	3 seconds

#### LIFT COMPENSATION:

If moisture level is < 0.2%, adjust as needed. The higher the lift percentage, the lower the moisture value will be. Call AZI Customer Service if you have any questions.

#### PARAMETER DOCUMENTATION:

To ensure optimum and efficient correlation, reproducibility, and for record keeping purposes, record the following.

- Standard testing - 3 Karl Fischer, 3 oven tests or other accepted reference method procedure.
- 5 repeat tests on the MAX-1000.
- Record comments on special techniques required to duplicate accurate and reproducible results.

If you need assistance with parameter development or have questions concerning the operation of the analyzer, please contact either your Sales Representative or Customer Service Representative at (800) 235-3600 or (602) 470-1414.

# 19 APPENDIX B

---

---

## 19.1 PARAMETER DEVELOPMENT - FOODS INDUSTRY

---

Following are the guidelines for developing parameters.

### TEST TEMPERATURES

Be sure to use a temperature that is high enough to drive off all the moisture but does not degrade the material in any appreciable way.

If, after establishing a test temperature, a shorter test time is desirable, try using HISTART temperature control. Begin with a HISTART temperature that is 20°C higher than the test temperature.

### STANDBY TEMPERATURE: 80°C

Adjust only with materials that would be affected with this elevated standby temperature.

When using small sample sizes of materials that lose moisture quickly, it is recommended that the pan or the pan w/filter paper (if used) be cooled after the pan tare and before adding the sample. This can be done quickly and easily by removing the pan or pan w/filter paper and fanning them back and forth a few times.

### ENDING CRITERIA:

If expected moisture content is greater than 20% or less than 0.5%, use RATE. If greater than 20% adjust rate in increments of 0.25/minute.

IE:	0.50%/minute
	0.75%/minute
	1.00%/minute
	1.25%/minute

If less than 0.5%, adjust rate in increments of 0.05% beginning at 0.25% and adjust down as needed.

If expected moisture is between 0.5% and 20%, use PREDICT.

MAX-1000 - Relaxed predict

If smaller standard deviations are needed:

MAX-1000 - Mid-range predict

If improved standard deviations are needed:

MAX-1000 - Tight predict

If standard deviations are still not acceptable, try RATE ending criteria.

**SAMPLE SIZE:** Adjust as necessary for application. Smaller sample sizes of a homogenous material will decrease test times.

**TARE OPTIONS:**

Pan tare:	Standard
Sample tare:	When stable. Use sample tare “3 seconds” with warm or hot applications.
Ultra-low pan tare:	With samples having moisture levels below 1%

**PARAMETER DOCUMENTATION:**

To ensure optimum and efficient correlation, reproducibility, and for record keeping purposes, record the following.

- Standard testing - 3 Karl Fischer, 3 oven tests or other accepted reference method procedure.
- 5 repeat tests on the MAX-1000.
- Record comments on special techniques required to duplicate accurate and reproducible results.

If you need assistance with parameter development or have questions concerning the operation of the analyzer, please contact either your Sales Representative or Customer Service Representative at (800) 235-3600 or (602) 470-1414.

## 20 WARRANTY

---

Arizona Instrument Corp. warrants the Computrac MAX-1000 to be free from defects in materials or workmanship for one year from the date of purchase. AZI will repair or replace, at its option, products which AZI determines to be defective during the warranty period. All defective parts replaced by AZI become the property of AZI. Replacement parts are warranted for the remaining portion of the effective warranty period. This warranty does not apply to expendable or maintenance items such as pans and pan supports.

The above warranty does not extend to any product which has been subjected to misuse, abuse, neglect, accident, improper application, modifications or service performed by persons other than AZI's own service representatives, power surges or spikes, negligence in use, maintenance, storage, transportation or handling, or an act of God.

If a MAX product is defective in workmanship or materials, the owner's sole remedy shall be repair or replacement of the defective part, or parts, as provided above. Under no circumstances shall AZI be liable in any way to the owner or any user for any damage including, but not limited to, any loss of business or profits or any other direct, indirect, special incidental, or consequential damages, whether or not foreseeable, and whether or not based on breach of warranty, contract, or negligence in connection with the sale of such products. (Some states do not allow the exclusion or limitation of incidental or consequential damages, so the above limitations or exclusions may not apply to you.)

**No other warranty is expressed or implied including the warranties of merchantability or fitness for a particular purpose. In no event shall AZI be liable for consequential and/or incidental damages.**

The effective warranty begins on the date of purchase by, or lease to, the first end-user (owner). Keep the dated bill of sale, or invoice, for evidence of the effective warranty date when warranty service is requested.

In the event that any questions or problems should arise in the use or application of your Computrac MAX-1000 unit, call AZI Customer Service or your Account Representative toll-free at (800) 235-3360 or (602) 470-1414.

## **21 MAINTENANCE CONTRACT**

---

Arizona Instrument Corp. has a high level of confidence in the reliability of the MAX. Our sophisticated circuits, advanced design and manufacturing techniques result in a unit that performs reliably over an extended period. To demonstrate our confidence, we offer an extended warranty maintenance contract. For a nominal annual charge, AZI will exchange any subassembly or repair any unit at the factory which fails through no fault of the user. This exchange or repair is on a no-charge basis, except for freight. Contact AZI and ask for the Maintenance Contract Sales Representative.

## **TRADEMARK AND COPYRIGHT PROTECTION**

Computrac, Arizona Instrument, AZI and the stylized AZI are all registered trademarks of Arizona Instrument Corporation. Copyright 1996, Arizona Instrument Corporation. All rights reserved.

MAX-1000 is a trademark of Arizona Instrument Corporation.  
Tygon™ is a registered trademark of the Norton Company.

## **ARIZONA INSTRUMENT CORPORATION COMPUTRAC DIVISION**

## **COMPUTRAC MAX-1000 MOISTURE ANALYZER USER'S MANUAL**

If you have any questions regarding the operation of this instrument, please call our toll-free number: (800) 235-3360. Internationally, call (602) 470-1414 or FAX (480) 804-0656.

Arizona Instrument LLC  
3375 N Delaware St  
Chandler, AZ 85225

(800) 528-7411  
(602) 470-1414  
Fax (480) 804-0656  
<http://www.azic.com>  
email:  
azi@azic.com - General  
intl@azic.com - International  
support@azic.com - Customer Support