



USER MANUAL

COMPUTRAC[®] VAPOR PRO[®] 3000 MOISTURE ANALYZER OPERATION MANUAL

Firmware Rev 1.002
February 1998

ARIZONA INSTRUMENT LLC

3375 N Delaware Street | Chandler, AZ 85225 USA
800.528.7411 | 602.470.1414 | f 602.281.1745

www.azic.com

Email:

General - azi@azic.com

International - intl@azic.com

Customer Service - support@azic.com

ARIZONA INSTRUMENT LLC
3375 N Delaware St | Chandler, AZ 85225
800.528.7411 | sales@azic.com | www.azic.com
MADE IN THE USA

AZI P/N 700-0012-C1
Last update February 1998

Computrac 3000™

PROPRIETARY RIGHTS NOTICE

The material in this manual contains valuable information developed by Arizona Instrument LLC for use with the Computrac line of moisture analyzers. No part of this manual can be reproduced or transmitted in any form or by any means, electronic, mechanical, or otherwise. This includes photocopying and recording or in connection with any information storage or retrieval system without the express written permission of Arizona Instrument.

ALL RIGHTS RESERVED

© Copyright 1998 Arizona Instrument LLC

Table of Contents

INTRODUCTION	Page 4 of 57
PRINCIPLES of OPERATION	Page 5 of 57
UNPACKING	Page 6 of 57
INSTALLATION	Page 7 of 57
Check Sensor Status	Page 9 of 57
Dry System	Page 10 of 57
CALIBRATION TESTS	Page 12 of 57
Syringe Technique	Page 12 of 57
Calibration Check	Page 14 of 57
Sensor Calibration	Page 15 of 57
RUNNING MOISTURE TESTS	Page 17 of 57
Select Test Settings	Page 17 of 57
To Enter Material Name	Page 17 of 57
To Set Programmed Test Temperature	Page 18 of 57
To Select Units for the Final Result Display	Page 19 of 57
To Select How to End the Test	Page 19 of 57
Run Moisture Test	Page 23 of 57
COMPUTRAC 3000 MENU SYSTEM	Page 24 of 57
MEMORY START MENU	Page 26 of 57
STORED DATA MENU	Page 26 of 57
CALIBRATION MENU	Page 26 of 57
SETUP MENU	Page 28 of 57
DIAGNOSTIC MENU	Page 29 of 57
CONDITION PROMPTS and SYSTEM FAILURE CODES	Page 30 of 57
Condition Prompts	Page 30 of 57
System Failure Codes	Page 32 of 57
COMMONLY ASKED QUESTIONS	Page 33 of 57
REPAIR AND MAINTENANCE	Page 38 of 57
APPENDIX A - ELECTRONIC BALANCE	Page 47 of 57
Unpacking and Setup	Page 47 of 57
The On/Off Switch	Page 49 of 57
Connecting the External Balance to the Computrac 3000	Page 50 of 57
The Zero Switch	Page 51 of 57
Unit of Weight Selection	Page 51 of 57
The Send Switch	Page 51 of 57
The Function Switch	Page 51 of 57
Auto-Calibration (CAL 1) - Using an External Calibration Weight	Page 52 of 57
RS-232 Front Panel Configuration	Page 53 of 57
APPENDIX B - SPECIFICATIONS AND RATINGS	Page 55 of 57

INTRODUCTION

Arizona Instrument is proud to continue its leadership developing new technology in the moisture analysis industry. The COMPUTRAC 3000 has been recognized by R&D Magazine as one of the 100 most technologically significant new products of 1997.

A revolutionary moisture analyzer with a detection limit of 10 ppm, the COMPUTRAC 3000 uses a sensor-based technology and correlates to the Karl Fischer coulometric titration method (with an oven attachment) in precision and accuracy. The analyzer does not utilize reagents, minimizes consumables, and is simple to operate.

1997 **Winner!**
R&D Magazine
Technology 100
Award

Principles of Operation: The COMPUTRAC 3000 heats a sample of test material in a septum bottle. Evolved volatiles are passed through a cold trap filter to an analysis cell, where the moisture content of the flowing gas is measured. A microprocessor integrates the varying moisture signal and converts the signal to micrograms of water for display. Results are available in parts per million, percent moisture, or total micrograms of water. Arizona Instrument's innovative prediction algorithm automatically terminates the test in just minutes when sufficient information is collected to allow accurate determination of the sample's moisture content. The heating range of the COMPUTRAC 3000 is 25 °C to 275 °C. Test parameters such as sample size, heater temperature and test ending criteria can be altered to optimize speed and accuracy.

Performance: Designed for either lab or production floor use, the **COMPUTRAC 3000** Moisture Analyzer uses patented, state-of-the-art technology specifically designed to provide accurate and precise results in a timely manner. This ensures that product quality is achieved and maintained.

The Computrac 3000 stores programmed memory settings for up to seven materials and retains the data from the last 30 sample test runs. The software automatically calculates the statistics of any selected stored data upon demand. All retained test data can be automatically sent to an external printer or personal computer at the end of a test or on request.

A factory-calibrated syringe provided in the accessory kit permits quick and easy system verification. System calibration is checked in just minutes. Re-calibration is a menu driven two-step procedure to assure accurate and reliable results day after day. Built-in self diagnostics constantly monitor system conditions to detect and report any abnormalities in the hardware, software, moisture sensor or flow system.

PRINCIPLES of OPERATION

The COMPUTRAC 3000 utilizes a cylinder shaped bottle heater, a dry-gas flow system and a moisture sensor. The instrument heats a sample of test material contained in a 20 ml (milliliter) septum bottle. Volatiles driven from the sample pass through the manifold containing the Relative Humidity (RH) sensor, where the evolved moisture is measured. A microprocessor uses the collected data to generate an accurate measurement of the moisture content in the sample. The instrument then displays the result in terms of:

- Parts per million (ppm) H₂O,
- Micrograms (μg) H₂O, or

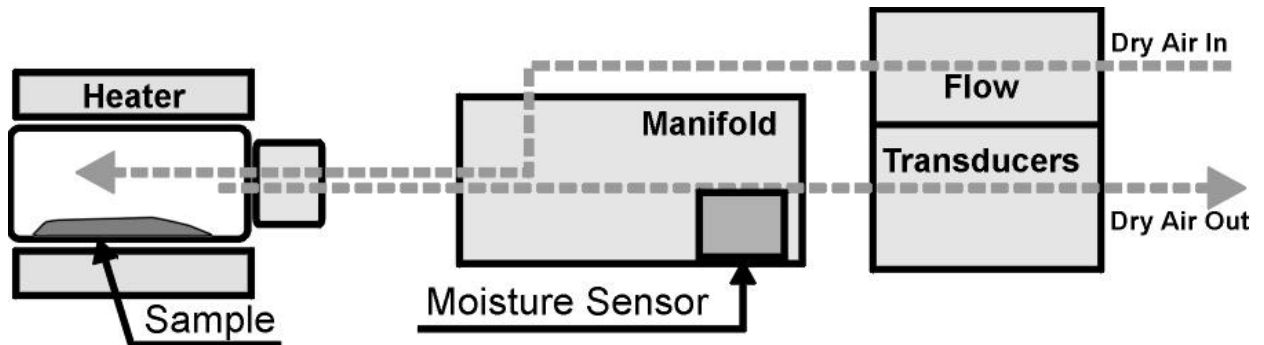

Figure 1 CT-3000 Basic Flow System

The main sensor used to detect water in the gas stream is a polymer capacitor relative humidity sensor. The reading from this sensor is combined with manifold temperature and outlet flow rate to determine absolute micrograms of water per second.

Test parameters such as temperature, ending criteria, and sample weight entry can be changed to optimize test speed and accuracy. See Appendix B, beginning on page 55, for detailed specifications and operating limits.

UNPACKING

Unpack the instrument and locate the following items:

	AZI P/N
• COMPUTRAC 3000	
• Line cord for 120 VAC	200-0002
• Accessory Kit	Y990-0063
▶ One 1.0 µl Hamilton Syringe	990-0068
▶ Ten 20 ml Sample Bottles with Septums and Caps	990-0064
▶ One Replacement Sample Probe	990-0057
▶ Two Injection Port Septums	990-0058
▶ One Hydrophobic Filter Disk	990-0059
▶ User's Manual	700-0012
▶ Power Cord	200-0002

Optional Items:

• Balance with interface cable	Y990-0082
• Printer	Y990-0098
• 101-key keyboard	990-0088
• Dry Air Generator	600-0169

If you are unable to locate any of the standard items or have questions regarding the optional accessories, please contact AZI Customer Service at (800) 528-7411 or (602) 470-1414.

INSTALLATION

- 2 Place the Computrac 3000 on a solid level surface that is large enough to accommodate the instrument and any accessories or materials that may be required for your work (balance, printer, sample bottles, samples, etc.).

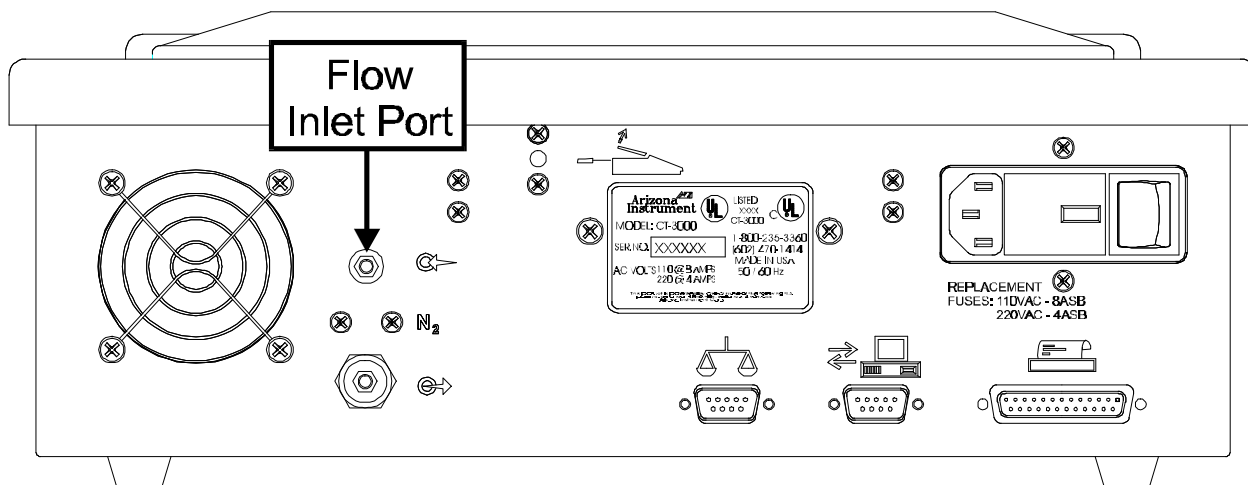

Figure 2 Rear Panel of the CT-3000

- 3 Using 1/4", formulation 2075, Tygon™ tubing, AZI P/N 345-0050, attach a dry nitrogen or carrier gas source to the **Flow Inlet Port** fitting on the back of the instrument, indicated by an arrow pointing to the connector.
- 4 Adjust the source pressure to between 7 and 12 psi.
- 5 If you plan to use a printer, electronic balance, and/or computer connect them to the marked connectors at the back of the instrument. The accessory keyboard plugs into a fitting on the right side of the instrument.
- 6 Power control and fuses are located at the rear of unit. Plug the instrument line cord into the matching port on the back of the instrument and a dedicated, 110 VAC, 60 Hz, 15 Amp line source. Never use any power cable other than the one provided or of equivalent UL listed ratings. Be sure that the ground pin of the power source is properly grounded. Never cover the power receptacle so that the power cord can not be removed quickly and easily.
- 7 Toggle the power switch at the rear of the unit to the ON (I) position.

- After a quick view of the instrument identification and the firmware version, the Main Test Screen will appear.

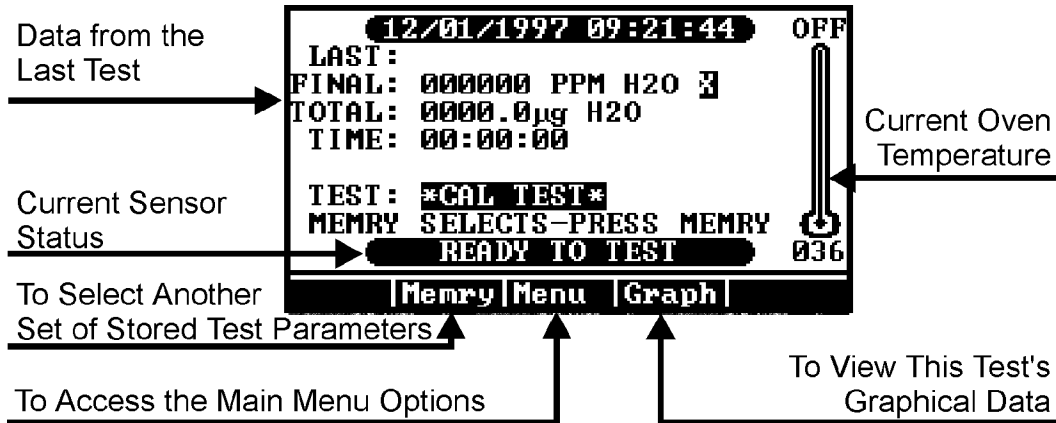

Figure 3 Main Test Screen

- Allow the instrument to warm up for 20 minutes.

Check Sensor Status

From the Main Test Screen, select **Menu** to reveal the **Main Menu**. Use the buttons below the display on the front panel to move through the menu screens and system settings.

- 1 Move the cursor down to highlight the **Diagnostic Menu**.
- 2 Press [Select].



Figure 4 Select Diagnostic Menu

- 3 Verify the **View System Sensor Status** option is highlighted.
- 4 Press [Select] again to view the **Sensor Status Screen**.



Figure 5 Diagnostic Menu

- 5 Adjust the nitrogen source pressure (if necessary but not to exceed 12 psi) so that the **Flow in** and **Flow out** rates are both at the optimum setting of **100 ml/min** (± 3 ml/min). NOTE that the flow out may read slightly higher than the flow in.
 - If the suggested rates are not obtained, see “How do I Calibrate the Flow Sensors?” on page 41.

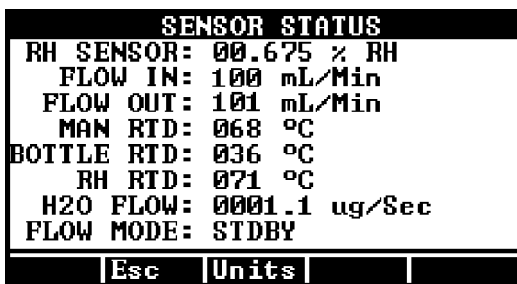

Figure 6 View Sensor Status Screen

- 6 Return to the Main Test Screen by pressing [Esc] three times.

Dry System

NOTES: For all tests using a bottle, the bottle should not be moved into the heater until a screen prompt appears directing that the bottle be inserted. If the bottle is moved in too soon, it may be ejected and the test results affected.

ENSURE the slick side of the septum is to the inside of the bottle or the moisture trapped in the septum will cause false moisture indications.

- 1 From the Main Menu, select in order:
 - Memory Start Menu
 - Add/Edit Memory Start
 - ***FILTER DRYDOWN***
- 2 ESCAPE to the Main Test Screen.
- 3 PREPARE a new, clean and dry, sample bottle to be positioned into the heater during the next set of steps.

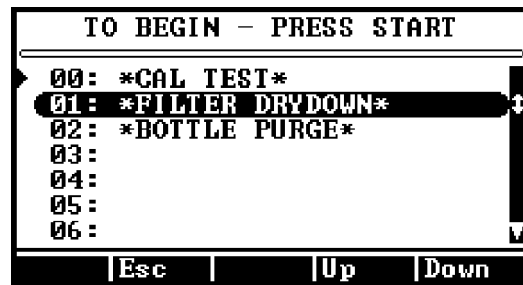

Figure 7 Select Filter Drydown

- 4 When the display indicates “Ready to Test,” PRESS START.
- 5 When prompted, insert the clean sample bottle into the heater.

- 6 When the instrument signals “End of Test:”
 - Depress [Menu],
 - Select Memory Start Menu
 - Select Add/Edit Memory Start
 - Select ***BOTTLE PURGE***

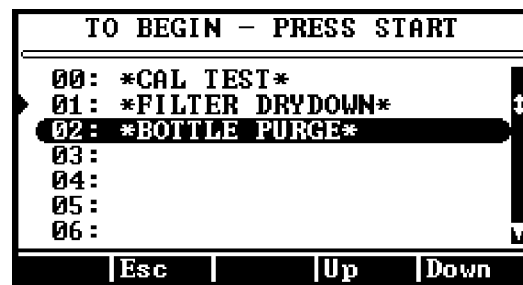

Figure 8 Select Bottle Purge

- 7 Press [Esc] several times until the Main Test Screen is displayed.
- 8 When the display indicates “Ready to Test,” PRESS START.
- 9 When prompted with

PLACE SAMPLE BOTTLE IN TRANSPORT AND INSERT UNTIL TRANSPORT IS LATCHED
--

, insert the sample bottle into the heater.

- 10 This test will run for 15 minutes to purge moisture that may have migrated into the system.
 - If the result is more than 100µg, repeat the bottle purge test.
 - If the result does not fall under 100µg after the 3rd or 4th test:
 - Ensure the slick side of the septum is to the inside of the sample bottle.
 - Check and/or change the hydrophobic filter, see page 39.
 - Call AZI Customer Service at (800) 528-7411 or (602) 470-1414.

CALIBRATION TESTS

The water calibration test verifies that the instrument is working properly. This test only takes a few minutes. Arizona Instrument recommends that:

- This test be run every day to verify the system's calibration and accuracy, and
- The syringe be returned for calibration annually or if damage is suspected.

Syringe Technique

The information presented here will help you perform the test described on the next page. The syringe uses the volume inside the needle as its calibrated quantity. It is important to eject any trapped air to properly fill that volume. Insert the syringe needle through the septum of a sample bottle of clean water (distilled or de-ionized water). Depress the plunger all the way down. Slowly withdraw the plunger to the stop. Rapidly depress the plunger all the way and observe the needle tip for small bubbles. If any appear, repeat the cycle until none appear. Slowly withdraw the plunger to the stop and hold it against the stop while withdrawing the needle from the septum. To prevent loss of water from the syringe by capillary action, do not touch the needle tip to anything until it is inserted into the calibration port of the instrument. When prompted by the instrument, place the needle tip in the injection port at the top of the instrument, and insert it straight down until the septum is contacted. Push it in until it touches the bottom of the injection port.

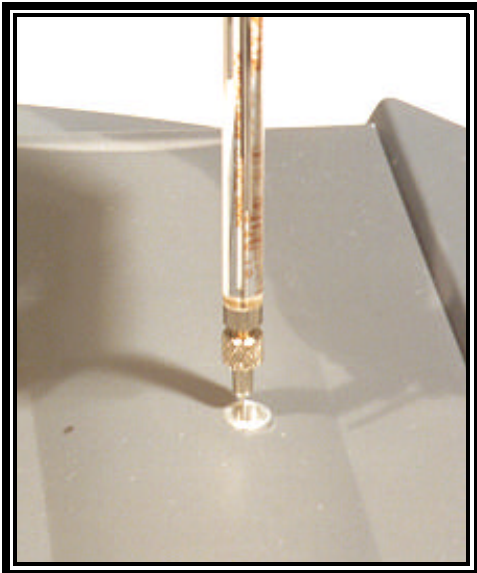

Figure 10 Correct Placement



Figure 11 Incorrect Placement

Be careful not to move the plunger while inserting the needle. Depress the plunger all the way with a firm, smooth stroke. Remove the needle from the injection port immediately.

Calibration Check

- 1 Ensure that the **TEST:** prompt on the main screen reads ***CAL TEST***. If not, press **[Memry]**, move the cursor up to highlight ***CAL TEST*** and press **[Selct]**.
- 2 Remove the one microliter syringe from the box.
 - The syringe has been factory set to approximately 500µg. The actual calibration value is written on the side of the syringe.
 - Depress the plunger to the stop. Insert the needle through the septum of a sample bottle containing distilled or de-ionized water.
- 3 Draw water into the syringe. Quickly cycle the syringe through its full stroke while in the water, to eliminate any air bubbles in the capillary and shaft.
- 4 Draw the water up slowly into the syringe.
- 5 Press the **[START]** key on the Computrac 3000. It is important to begin the test promptly since the water will evaporate out of the syringe needle. Almost immediately, the screen will display the blinking message **“HAND INJECT WATER NOW.”**
- 6 Inject the sample by inserting the syringe needle all the way down into the injection port. The rounded needle tip should touch the bottom. Depress the syringe plunger; wait a second or two and remove the needle. This method will help to optimize the water transition and minimize the test time.
- 7 Allow the test to proceed until completed. It should take less than 3 minutes.
- 8 If desired, perform another four calibration injections and calculate the statistics for the water injection results for instant performance analysis.
 - To do this, press **[Menu]** for MAIN MENU,
 - Press **[Selct]** for STORED DATA MENU,
 - Press **[Selct]** for ANALYZE STORED DATA,
 - Highlight and **[Selct]** the desired results to be included in the statistics, and
 - Press **[STAT]** to calculate Average, Standard Deviation, and Coefficient of Variation.
- 9 The average should fall within $\pm 5\%$ of the calibrated syringe's value.
- 10 If the mean result does not fall within the $\pm 5\%$ range, a sensor calibration should be performed.



Figure 12 “CAL TEST” Displayed

Sensor Calibration

NOTES:

- Only a one microliter, (1 μ l), syringe which has been calibrated to .5 μ l, with the exact weight in μ grams clearly visible will be used for this calibration or an NIST traceable syringe set to .5 μ l/500 μ g.
- This syringe has a very small barrel and piston which must be properly cared for to assure a correct injection is delivered to the instrument. After first use, the syringe must be stored in a desiccant box or it will become immobilized internally.
- Once the syringe has become immobilized, it should be replaced.
- The syringe should be returned to AZI annually for calibration or if damage is suspected. Contact AZI Customer Service at (800) 528-7411 or (602) 470-1414 to obtain a Return Material Authorization (RMA) number and prompt replacement.
- AZI Part Numbers of most used items:
 - ▶ SEPTA, Injection Port 990-0058
 - ▶ FILTER, Hydrophobic 990-0059
 - ▶ BOTTLE, Sample, (Black top only) 990-0064
 - ▶ SYRINGE, 1 μ liter, calibrated to 0.5 μ liter 990-0068
 - ▶ SEPTA, Sample Bottle 990-0074

- 1 SELECT IN ORDER:
 - Memory Start Menu
 - ADD/EDIT Memory Start
 - *Cal Test*
- 2 Press [Esc] several times until the **Main Test Screen** appears.
- 3 Prepare the Syringe with distilled or deionized water.
 - Insert the syringe into the water bottle and fill the syringe.
 - Rapidly depress the syringe's plunger to expel any air in the barrel.
 - Fill the syringe and hold the plunger against the stop.
 - Remove the syringe from the bottle.
- 4 When the "READY TO TEST" is displayed:
 - Depress the Start Button.
- 5 When the "INJECT WATER NOW" prompt flashes on the display:
 - IN ONE CONTINUOUS MOTION;
 - ▶ Insert the syringe into the instrument to the stop,
 - ▶ Rapidly press the plunger down, and
 - ▶ Remove the syringe.

NOTE: EACH TEST WILL TAKE ABOUT TWO (2) MINUTES.

- 6 When the instrument again indicates “READY TO TEST,” perform steps 3 through 5 at least four (4) more times, for a total of five (5) valid results within 10µg of each other.
- 7 When the five tests results are available, press **[Esc]** several times until the Main Test Screen appears.
- 8 Select the **Stored Data Menu**
- 9 Select **View Stored Data**
 - Delete those test which are out-of-limit due to poor syringe technique.
 - Delete any tests not of this test cycle.
 - Press **[Esc]** to return to the **Stored Data Menu**
- 10 Select **Analyze Stored Data** and review each test.
 - Valid tests should be within 10 µgrams of each other.
 - Select the five closest results.

NOTE: At least five (5) valid tests are required for the proper analysis and correction factors to be calculated. If five valid results are not available, repeat the tests until they are available.

- 11 Depress **[STAT]**:
 - Review the results of the calculation
 - Standard Deviation should be less than 10%
 - Coefficient of Variation should be less than 2%

12 Select **Calibration Menu**.

13 Select **Perform Calibration**.

- 14 The result screen will look similar to the sample at left.
 - Press the **[Accpt]** Key to store these new results into memory.

Number of Tests	5
Average	519.7 ug
Standard Deviation	7.8 ug
Coefficient of Variance	1.5%

Sample Calibration Display

- 15 The new calibration numbers will remain in memory until the next sensor calibration is performed. The injections used for this calibration will be automatically marked so they will not be used for the next calibration.
- 16 Press the **[Esc]** key several times until the **Main Test Screen** appears.
- 17 Perform at least one more water injection to verify the accuracy of the calibration.

RUNNING MOISTURE TESTS

The Computrac 3000 has seven available positions to store test parameters for different materials. Storing the parameters ensures that each test of the same material will use the same parameters to assure accurate, reliable, and repeatable testing.

Select Test Settings

- 1 From the **Main Menu**, select **Memory Start Menu**.



Figure 13 Memory Start Menu

- 2 From the **Memory Start Menu** select **Add/Edit Memory Start**.
- 3 Move the cursor down to an available memory start setting (a blank line).



Figure 14 Memory Start Menu

To Enter Material Name

- 4 Press **[Selct]** then **[Edit]** at the Edit Sample ID line.
 - 4.1 Use the ▲ and ▼ arrow keys to scroll through the alpha-numeric characters. The ◀ and ▶ arrow keys move the cursor's position left and right.

"TIP"

Use the arrow keys on the 101-key keyboard to navigate the menu system if it is included with your system.

The keyboard makes entry of long strings of characters such as product names easy, since all the alphabetic and number keys can be used while editing.

- 5 Move the cursor all the way to the end of the line, then press the **Quit**, then the **Accept** keys.

To Set Programmed Test Temperature

- 6 Determining the Test Temperature.
 - 6.1 Generally, use the highest temperature possible without causing other ‘undesirable’ conditions (such as melting or excessive release of other volatiles). The instrument is relatively insensitive to the exact temperature used. Too low a temperature will result in slow tests and possibly low results. It is important that the sample not melt in most cases. A melted sample may form an impermeable skin and trap moisture, resulting in a low answer. If the melting temperature is known, use a temperature 10 or 20 degrees lower. If it is not known, start at a high temperature (230 to 270) and lower it until the sample no longer melts. The following guidelines will help to determine test temperature.
 - 6.2 If you are testing pelletized resins or a similar material set the test temperature to 230°C or the same temperature as used in a pyrolysis oven attachment to a Karl Fischer (KF) titrator.
 - 6.3 If you are testing any other type of material set the temperature to 130°C.
 - 6.4 Run a moisture test.
 - If the sample doesn’t melt, raise the temperature 10°C and return to step 6.4.
 - If the sample melts, lower the temperature 10°C and repeat the test until condition is no longer observed.
- 7 Highlight the “**Temperatures**” on the **Edit Memory Start Menu**.
- 8 Press [**Selct**], then [**Edit**].
 - Use the ▲ and ▼ arrow keys to select the desired testing temperatures. The ◀ and ▶ arrow keys move the cursor’s position.
- 9 When complete, move the cursor to the end of the line. Press [**Quit**], then [**Accpt**].

To Select Units for the Final Result Display

- 10 Highlight the Result Display Option line.
- 11 Press **[Selct]**, then **[Edit]**.
 - 11.1 Use the ▲ and ▼ arrow keys to select the type of moisture value for the test result to be displayed. Either:
 - Percentage, (%) of water,
 - Parts per million (ppm) of water, or
 - Micrograms (µg) of water measured.
- 12 Press the **Quit**, then the **Accept** keys.

To Select How to End the Test

- 13 Highlight the Ending Criteria line.
- 14 Press **[Selct]**, then **[EDIT]**.
 - 14.1 Use the ▲ and ▼ arrow keys to choose the type of ending value.
 - **Rate** ends the test when the moisture evolved from the sample drops below the programmed microgram per second value. Use RATE if you want to match an existing standard or method that utilizes a RATE criteria (such as the KF titration method). This method is extremely dependent on the amount of sample used and water collected during a test. For repeatability testing, use a very consistent sample size that is within ± 10 percent.
 - **Predict** ends the test when the built-in programmed criteria, which mathematically calculates the end point moisture content, has been satisfied. Use PREDICT if you want to more accurately determine the actual moisture content or are working independently of other standards or methods. This potential calculation monitors moisture loss from the sample to extrapolate the final moisture concentration and provides the quickest test times.
 - **Time** ends the test when the programmed testing period has elapsed. The test will end when a selected amount of time has passed. Any value from 001 to 999 minutes may be entered. Fixed time ending is seldom superior to the predict calculation but is useful when conducting application characterization tests, or when investigating long term stability of the instrument.

- 15 If you are attempting to match KF analysis results, find out what sample size and ‘sensitivity’ setting was used in the KF procedure. Use approximately ten times as much sample in the Computrac 3000, and set the rate ending criteria value to ten times the ‘sensitivity’ value used in the KF equipment.

Example:	KF Sensitivity Setting 0.1 µg/sec	KF Sample Size 0.5 grams
	Computrac 3000 End Rate 1.0 µg/sec	Computrac 3000 Sample Size 5 grams

- 16 If you do not have the KF parameters available, perform the following experiment.
- 16.1 Select a sample size that will yield 500 to 1000 micrograms of water, or use the table below.

Expected Moisture		Use
0 - .005%	0-50 ppm	10-20 grams
.005 - .015%	50-150 ppm	5-10 grams
.015 - .035%	150-350 ppm	2-5 grams
.035 - .075%	350-750 ppm	1-2 grams
.075 - .150%		0.5-1 gram
.150 - .350%		0.2-0.5 gram
.350 - .750%		0.1-0.2 gram
.750 - 1.5%		0.05-0.1 gram

- 16.2 For best accuracy and speed, the sample should evolve between 500 and 1000 micrograms of water during the test. Larger amounts will not significantly improve accuracy, and will only add to the test time. Smaller quantities will result in faster tests but may degrade accuracy, depending on the properties of the sample. No damage to the instrument will ensue if samples are too small, but samples that evolve more than about 10,000 micrograms of water or other volatiles may result in condensation of water or volatiles in the output flow sensor, damaging it.
- 16.3 To estimate sample size, you must have some idea of the approximate moisture content of the sample. Use the calculation shown below to estimate the minimum sample size.

$$\text{Minimum Sample Grams} = \frac{0.05}{\text{Expected Moisture \%}} \quad (500\mu\text{g water})$$

Example: Expected Moisture is 0.05%
 Minimum Sample = 0.05/.05 = 1.0 grams

16.4 Similarly, the maximum sample is determined by what size sample will release 1000 micrograms of water.

$$\text{Maximum Sample Grams} = \frac{0.1}{\text{Expected Moisture \%}} \quad (1000\mu\text{g water})$$

Example: Expected Moisture is 0.05%
Maximum Sample = $0.1/0.05 = 2.0$ grams

16.5 These are only guidelines. Experiment with your sample to refine the size estimates to achieve your desired speed and accuracy. Note that if you are using a rate ending criterion, and the peak moisture rate is less than 5 times the rate threshold, the sample sizes should not be allowed to vary more than about 10%. Larger variation of sample size will lead to a larger variation of results.

17 If you are not trying to match KF analysis results perform the following experiment.

17.1 Set up the instrument to use time ending, and set the time to 20 minutes.

17.2 Pick an appropriate temperature
(See “Determining the Test Temperature” on page 18.)

17.3 Run a test and observe the peak rate on the Rate Graph.

17.4 Use a rate ending value smaller than 1/3 the peak rate, but larger than 0.2 micrograms per second.

17.5 Press [Quit], then [Acpt].

17.6 Press [Esc] several times to return to the **Main Test Menu** and verify that:

- The name of the test appears next to “TEST:” and
- “READY TO TEST” appears in the status window at the bottom center of the screen.

18 After determining the optimum test parameters, repeat the test once to confirm the results.

18.1 For performance data, run 3 to 5 tests and determine the statistics by:

- Select **Stored Data** from the **Main Menu**,
- Select Analyze Stored Data,
- Select the test results you want to analyze, and
- Press [Calc].

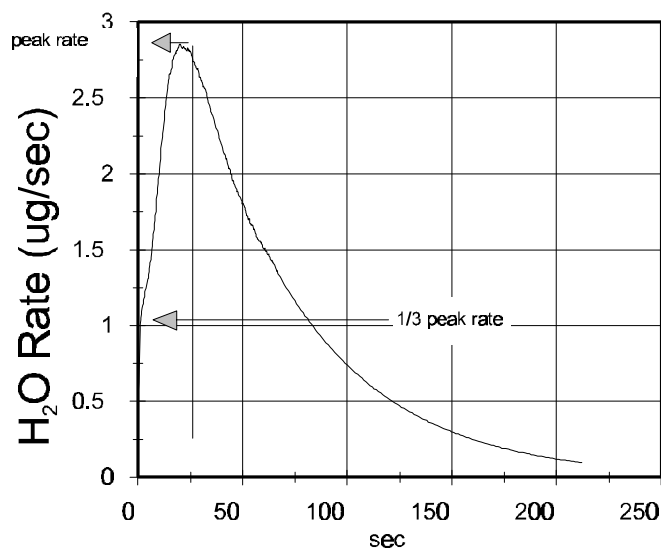

Figure 15 Example of Graph

Run Moisture Test

- 19 Tare-weigh a clean, empty sample bottle, including the septum and cap. Based on the expected moisture content of the sample, determine optimum sample size using the chart on page 20.

NOTES: Fill the bottle no more than ½ full. ENSURE the slick side of the septum is to the inside of the bottle.

- 19.1 Weigh the loaded bottle and record the weight of the sample.
- 19.2 Press [START].
- 19.3 When prompted, enter the net sample weight and insert the bottle. The system will purge the bottle for 28 seconds. The sensor will again zero and the test begins.
- 19.4 An audible ‘beep’ will sound when the instrument has completed the test. Use the table on page 20 and the FINAL moisture reading on the display to adjust the sample size accordingly to optimize test time, repeatability and accuracy.

TIP

The accessory balance, AZI P/N Y990-0082, eliminates possible transcription errors when entering the sample weight. It is also faster than manually taring and weighing the sample.

COMPUTRAC 3000 MENU SYSTEM

- 1 In the idle state, the Main Test Screen displays menu access keys at the bottom. From left to right they are:
 - **[Memry]** key - for accessing stored memory start selections,
 - **[Menu]** key - for accessing the Main Menu, and
 - **[Graph]** key which changes the display to a graph of collected moisture and rate information.

- 2 Use either the ◀ and ▶ or ▲ and ▼ arrow keys to make your selection.

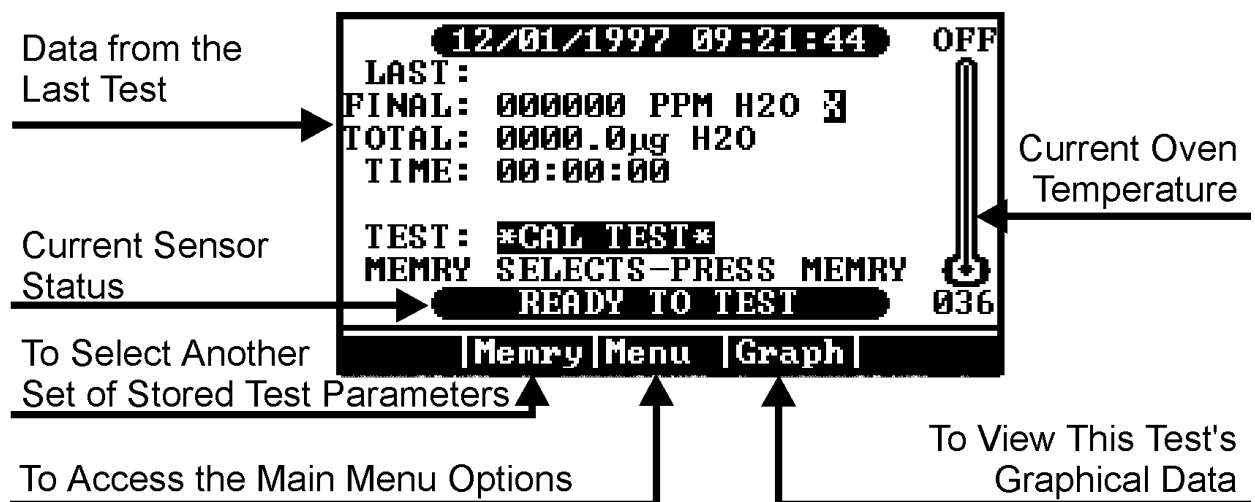

Figure 16 Main Test Screen

- 3 The **[Graph]** key can be used to switch the display to the graphical displays.
 - 3.1 When **[Graph]** is pressed, the Total Moisture Graph appears and the name above the arrow button changes to **[Next]**.
 - 3.2 When **[Next]** is pressed, the graph changes to display the rate at which moisture is passing over the sensor.
 - 3.3 Pressing **[Next]** will now toggle between the two graphs.

- 4 To return to this Main Test Screen press **[Esc]**.

5 Pressing [Menu] brings up a screen (see Menu Overview Screen below) showing the following options:

- MEMORY START MENU
- STORED DATA MENU
- CALIBRATION MENU
- SETUP MENU
- DIAGNOSTIC MENU

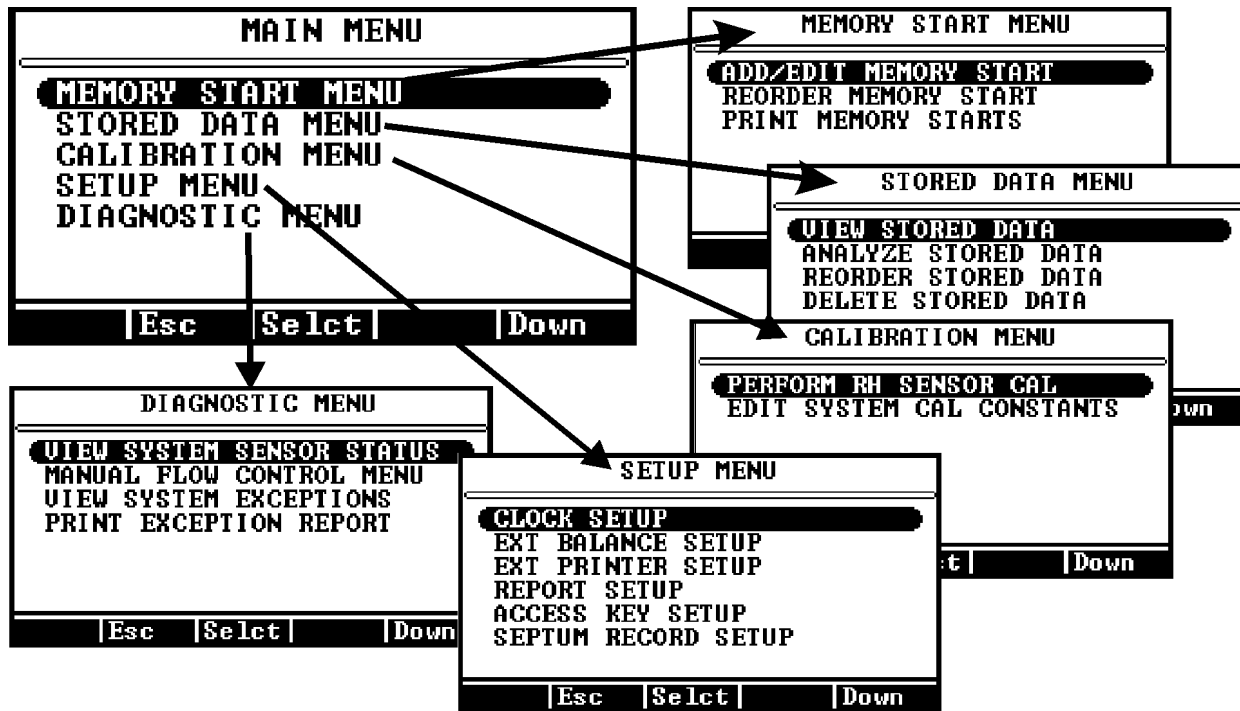

Figure 17 Main Menu Selections

6 Use the ▲ and ▼ arrow keys to scroll through the selections and the ◀ and ▶ arrow keys to “Escape” or “Select” your choice. Note that for some of the later selections, the ▲ and ▼ arrow keys will cycle through available letters and numbers so that names can be spelled and numeric values may be entered.

MEMORY START MENU

- ADD/EDIT MEMORY STARTS
 - ▶ Sets the values for stored test parameters. The parameters are stored by name. Values are stored for test temperature, ending criteria, method of entry of sample weight, and bottle purge control.
- REORDER MEMORY STARTS
 - ▶ Allows the list of stored parameter sets to be rearranged. It also deletes sets no longer needed, or copies existing sets to another location using the 'cut and paste' method.
- PRINT MEMORY STARTS
 - ▶ Prints a list of the stored parameter sets on the attached printer, or to an attached computer. See Printer Setup and Report Setup, Report Content to arrange the instrument for this purpose.

STORED DATA MENU

- VIEW STORED DATA
 - ▶ Allows viewing and printing of all data stored for a given test.
- ANALYZE STORED DATA
 - ▶ Permits selection of stored data sets for statistical analysis. Statistical analysis includes mean, standard deviation (S.D.) and coefficient of variation (C.V.).
- REORDER STORED DATA
 - ▶ Rearranges the order of the list of stored data sets. It also deletes sets no longer needed, or copies existing sets to another location using the 'cut and paste' method.
- DELETE STORED DATA
 - ▶ Facilitates deletion of selected data sets. Selection by line, date or all items.

CALIBRATION MENU

- PERFORM RH SENSOR CALIBRATION
 - ▶ To be used carefully and only when required to calibrate the moisture sensor. When this selection is made the stored data sets and the calibrated syringe volume are used to calculate and execute the automatic adjustment of the instrument calibration constant.
- EDIT SYSTEM CALIBRATION CONSTANTS
 - ▶ This selection allows the entry of the two sensor constants, written on the sensor card, when a flow manifold is replaced and the adjustment values to calibrate the flow sensors.

SETUP MENU

- CLOCK SETUP
 - ▶ Sets the internal clock for the correct time and date.
- EXT. BALANCE SETUP
 - ▶ Identifies the type of external balance (AZI SP150 or SCI SA80),
 - ▶ Selects the tare mode (fixed or manual bottle weight entry or balance entry), and
 - ▶ Verifies the communication link between the instrument and balance
- EXT. PRINTER SETUP
 - ▶ Identifies the type of data printer used and specifies where the output data is to be sent (RS-232, LPT or both).
- REPORT SETUP
 - ▶ **Report Control** specifies when the report is to be printed (off, at the start, at the end), selects the output format (text or spreadsheet), specifies the reporting interval in seconds, turns on or off end-of-line automatic formfeeds, selects which graph to print (both, rate, result, none), and turns lot number recording on or off.
 - ▶ **Report Content** specifies whether particular items of information are to be included in the report, or not. These items are:
 - Memory Start Number
 - Memory Start ID Text String
 - Lot Number
 - Product ID Text String
 - Test Date and Time
 - Final Result (ppm or %)
 - Final Mass (micrograms H₂O)
 - Ending Criterion
 - Sample Weight
 - Test Time
 - Test Temperature
 - Ending Rate (micrograms/sec at end of test)
 - ▶ **Edit Company Name** allows you to change the company name that prints on the header line of the report.
- ACCESS KEY SETUP
 - ▶ Allows entry of the secret access codes used to prevent unauthorized alteration of stored parameter sets, or stored data sets. The master key controls all functions. The Params key controls memory start parameter list access.
- SEPTUM RECORD SETUP
 - ▶ This function resets the injection port septum counter. When the septum has been used 60 times, a message will warn the operator to replace it. When the replacement is accomplished, use this function to reset the count to zero.

DIAGNOSTIC MENU

- VIEW SYSTEM SENSOR STATUS
 - ▶ Displays RH sensor value, flow in and out, manifold temperature (RTD*), bottle heater temperature, RH sensor temperature, H₂O flow rate and instrument flow mode.
- MANUAL FLOW CONTROL MENU
 - ▶ This menu allows manual control of the carrier gas flow mode for test and analysis of possible system faults. There are five selections.
 - Sensor Drydown** (high flow through the manifold and RH sensor but not the needle or bottle)
 - Standby** (normal flow, through the manifold and RH sensor)
 - Bottle Purge** (high flow through the needle and bottle, vented)
 - Sample Test** (low flow through all components, bottle must be present)
 - Off** returns the system to automatic control of the flow state.

NOTE: If any manually controlled flow state is used, ensure the manual flow control is set to off before attempting normal operation. If this is overlooked, an error message will be displayed on the main screen.

- VIEW SYSTEM EXCEPTIONS
 - ▶ A list of the last 20 faults detected by the instrument diagnostic system. Print the list and fax it to AZI Customer Service at (602) 470-1888 to assist in diagnosis of possible system failure.
- PRINT EXCEPTION REPORT
 - ▶ Prints the stored list of instrument diagnostic exceptions.

* RTD stands for Resistive Temperature Detector, and describes the solid state devices used throughout the instrument to measure temperatures.

CONDITION PROMPTS and SYSTEM FAILURE CODES

To assure proper performance, your Computrac 3000 uses an intelligent self-diagnostic system to detect any problems in the hardware, software, sensors or flow system. Operating abnormalities and fault conditions will result in **system failure codes** or **condition prompts**. They will be recorded in the Exception Reports table.

Condition Prompts

Condition prompts indicate operating conditions that prevent starting or completing of a moisture test. Following each condition prompt are possible causes and recommended solutions.

1 “EXCESSIVE IN/OUT FLOW RATIO”

This prompt indicates that the carrier gas flow out of the instrument is less than 90% of the flow into the instrument, suggesting a leak.

Possible Cause	Recommended Solution
Faulty bottle septum	Replace bottle septum
Faulty bottle cap	Replace bottle cap
Flow system leak	Locate and eliminate leak
Flow system out of calibration	Calibrate flow system

2 “INPUT CARRIER GAS FLOW LESS THAN 40 mL/Min”

This prompt results when the source flow into the instrument falls below the specified rate.

Possible Cause	Recommended Solution
Source of carrier gas not connected	Connect source
Source pressure too low	Increase source pressure to 7-12psi
Flow system plugged	Locate and eliminate blockage
Source connected to ‘flow out’ barb	Connect to ‘flow in’ barb
Flow sensor failure	Call Arizona Instrument
Blocked Needle	Check that bottle septum is not blocking needle port

3 “THE RH SENSOR WAS NOT READY

This is a normal condition between tests, indicating the drying or ‘zeroing’ of the sensor. If the condition persists for more than a few minutes then:

Possible Cause	Recommended Solution
Flow system contaminated	Locate and eliminate contamination
System unusually wet	Wait for system to dry
Wet source gas	Install/change external desiccant chamber

4 “SEPTUM CHECK WARNING”

The septum, at the calibration injection port, has experienced 60 or more water injections and may be in danger of losing its core into the flow system. Change the septum and reset the counter by selecting [SETUP MENU] (from the MAIN MENU), then [SEPTUM RECORD SETUP], then [Go].

5 “BOTTLE RELEASED WHILE TESTING”

This prompt results from premature release or ‘ejection’ of the sample bottle during a moisture test. Failure of the transport latch is the most likely cause. If this condition persists, call the Arizona Instrument Customer Service Department at (800) 528-7411 or (602) 470-1414.

6 “BALANCE COMM FAILURE”

This prompt indicates that the memory start used specifies use of a digital balance for weight entry, but the instrument is not communicating with a balance. Check the cable, and assure that the balance is powered on, on line, and stable.

System Failure Codes

Occurring less frequently than condition prompts, system failure codes require the instrument to be switched off and then powered back up. It is possible for a failure to occur due to a transient condition. However, if the failure persists or occurs frequently, call Arizona Instrument Customer Service at (800) 528-7411 or (602) 470-1414.

ERROR	ERROR MESSAGE TEXT	MOST LIKELY CAUSE
1	TRANSPORT RELEASE ERROR	STUCK BOTTLE RELEASE
2	PC KEYBOARD COM FAIL	BAD CABLE OR CONFIG
3	PC KEY CONTROLLER TIMEOUT	DEAD KEYBOARD
4	FLOW CALIBRATION WARNING	FAILED FLOW SENSOR
5	RH SENSOR RANGE ERROR	FAILED RH SENSOR
6,7	FLOW SYSTEM ERROR	CABLE OR SENSOR FAIL
8	RH RTD RANGE ERROR	CABLE OR RTD FAIL
9	RH RTD RATE ERROR	MANIFOLD HEATER
10	RH RTD TRACK ERROR	MANIFOLD RTD OUT OF POSITION
11	BOTTLE RTD RANGE ERROR	CABLE OR RTD FAIL
12	BOTTLE RTD RATE ERROR	BOTTLE HEATER FAILURE
13	BOTTLE HEATER OVERTEMP	BOTTLE HTR RTD OUT OF POS'N
14	BOTTLE HTR CONTROL ERR	ROOM TOO COLD
15	MANIFOLD RTD RANGE ERROR	CABLE OR RTD FAILURE
16	MANIFOLD RTD RATE ERROR	MANIFOLD HEATER FAILURE
17	MANIFOLD HEATER OVERTEMP	MANIFOLD RTD OUT OF POSITION
18	MANIFOLD HTR CONTROL ERR	MANIFOLD HTR OUT OF POSITION
19	A2D INIT FAILED	COMPONENT FAILURE, MAIN BOARD
20	A2D TIMEOUT ERROR	COMPONENT FAILURE, MAIN BOARD
21	MCU CLOCK FAIL ERROR	COMPONENT FAILURE, MAIN BOARD
22	COP TIMEOUT ERROR	COMPONENT FAILURE, MAIN BOARD
23	ILLEGAL OP CODE TRAP	COMPONENT FAILURE, MAIN BOARD
24	EPROM CHECK SUM FAIL	COMPONENT FAILURE, MAIN BOARD
25	SRAM CHECK FAIL	COMPONENT FAILURE, MAIN BOARD

COMMONLY ASKED QUESTIONS

Below are some commonly asked questions with answers and possible solutions.

Q: “What if my water injection results are zero (or near zero).”

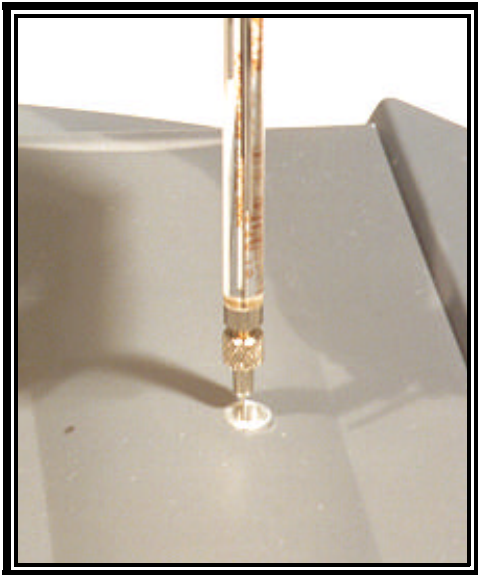

Figure 18 Correct Placement



Figure 19 Incorrect Placement

A: Make sure the syringe is being inserted all the way into the injection port.

Q: “What if my water injection results are out of range?”

A: Perform a sensor calibration. The Computrac 3000 self-adjusts the internal calibration factors to the high precision moisture sensor, due to varying conditions (temperature, product accumulation in the flow system, component wear, etc). Over time, this may cause the overall calibration to drift slightly. Since sensor calibration is easily performed, daily verification is recommended.

Q: “How do I dry the instrument after an upset?”

- A:** In case the instrument has been flooded with moisture, either by running a very wet sample, or by exposure to a wet atmosphere, it will be necessary to dry the entire flow system before normal operation can be resumed.
- 1 Inspect the filter, tubing, the needle and mount to be sure that no contaminants are present that might absorb and release large quantities of water. If contamination is present, replace the contaminated parts with new parts.
 - 2 Confirm that the carrier gas supply is dry. If there is any doubt about this, employ a drying cylinder in line with the gas supply before connecting it to the instrument gas input fitting.
 - 3 Begin drydown of the system. Place a clean, dry sample bottle, ensuring that the slick side of the septum is to the inside of the bottle, in the transport. Go to the memory start list and select *FILTER DRYDOWN.* Start the test and insert the bottle. Periodically examine the rate graph display, and see if the moisture rate is falling. If it remains at a very high level until the end of the test, a source of water is present in the system, and must be removed before dry-down will succeed. Normally, the rate will begin to decline after a short time, and eventually will fall to less than 1 µg/sec. When this occurs, a READY TO TEST message will appear on the display and testing can resume.

Q: “What about interferences?”

A: The only known interference is methanol. Samples containing methanol should never be used. Never use methanol as a cleaning agent with the Computrac 3000.

Q: “What is good syringe technique?”

- A:** Good syringe technique is essential to accurate calibration. The syringe uses the volume inside the needle as its calibrated quantity. It is important to eject any trapped air to properly fill that volume. Insert the syringe needle through the septum of a sample bottle of clean water (distilled or de-ionized water). Depress the plunger all the way down. Slowly withdraw the plunger to the stop. Rapidly depress the plunger all the way and observe the needle tip for small bubbles. If any appear, repeat the cycle until none appear. Slowly withdraw the plunger to the stop and hold it against the stop while withdrawing the needle from the septum. To prevent loss of water from the syringe by capillary action, do not touch the needle tip to anything until it is inserted into the calibration port of the instrument. Start a *CAL TEST* (see page 14). When prompted by the instrument, place the needle tip in the injection port at the top of the instrument, and insert it straight down until the septum is contacted. Push it in until it touches the bottom of the injection port. Be careful not to move the plunger while inserting the needle. Depress the plunger all the way with a firm, smooth stroke. Remove the needle from the injection port immediately.

Store the needle in a dry place. A desiccator box is a good choice. If water is allowed to remain in the needle, it will cement the needle bore and plunger wire together. If this happens, do not force the plunger to move, as this will break the wire. Instead, insert the needle into the water bottle and let it soak for 15 minutes, or until it moves freely.

If the syringe is damaged, or is in need of annual calibration, contact Customer Service at (800) 528-7411 or (602) 470-1414 for a replacement. After receiving an RMA number, return the damaged syringe to AZI for repair service.

Q: “Why do my tests sometimes end in less than 2 minutes?”

A: This is usually caused by an inappropriately large rate ending criterion value. Recall that when using the rate ending criterion, you entered a rate value to end on. If the sample moisture is very low, or the sample is too small, the peak rate never exceeds the ending rate, and the instrument concludes that the test is over. To rectify this, use a larger sample, or a lower ending rate value. See *“To Select How to End the Test”* beginning on page 19.

Q: “How do I transfer stored data to a computer file?”

A: To store archival information in a computer text file before deleting it from the instrument memory, set up the instrument to print to the RS-232 port. (Setup Menu, External Printer Setup). Go to Setup Menu, Report Setup, Report Control and select text output. Go to the screen showing Print and select the report to be printed. Set up the computer to receive text information into its serial port at 9600 baud, no parity, 8 data bits and 1 stop bit (9600,N,8,1). Windows Terminal, or Windows 95 Hyperterminal are good choices for this purpose. DOS users should use Procomm or Terminate, or equivalent utilities. Consult the documentation for your communications program for details on how to save input data to a file.

Q: “How do I print to a printer?”

A: To print test results or stored data:

- 1 Connect the printer to the parallel port on the back of the instrument. Use the accessory printer from AZI, or a standard PC graphics printer and cable.
- 2 Make sure the printer is supplied with paper, the printer power is on, and the printer is on-line.
- 3 Go to Setup Menu, and External Printer Setup. Select the Printer Type and LPT port.
- 4 Go to Setup Menu, Report Setup, and Report Control. Select text output.
- 5 Go to the screen showing Print and select the report to be printed.

REPAIR AND MAINTENANCE

Routine maintenance consists of checking the filter for clogging or contamination, checking the needles for clogs, and cleaning of the flow path between the needle and the filter. For clean samples, such as most plastic resin pellets, this is seldom necessary. For very dusty samples, it may be necessary more often.

CAUTION:

Line voltage is present under the instrument's cover. To prevent electrical shock, turn off power and remove the power cord when instructed to do so. Do not re-connect the power cord and turn power on until after the cover is secured in place.

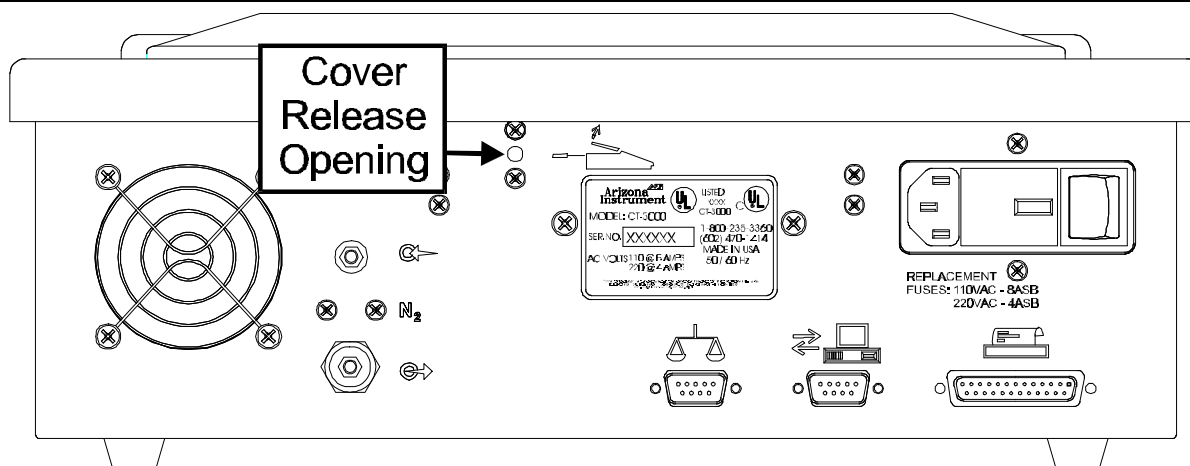

Figure 20 Cover Release Location

To inspect the filter and tubing, unplug the power cable. Then insert a small probe into the hole at the back of the instrument. It is marked by a graphic symbol indicating the method of opening the top cover. Push inward to release the safety catch, and lift the cover up with your free hand. Remove it and put it in a safe place. The filter is visible at right center, above the manifold. **Be careful not to contact the bottle heater rim as it may be hot enough to cause a burn.** Examine the filter and flex tubing.

If a deposit or discoloration is observed in the flex tubing between the filter and the manifold, the filter and tubing should be replaced, and the entire sample flow path cleaned with isopropyl alcohol.



*****IMPORTANT*****



Never use methanol for cleaning any part of the instrument. Methanol interferes with calibration of the RH sensor, and is very difficult to remove once introduced into the flow system.

The Hydrophobic Filter on top of the manifold is expected to be replaced when it becomes contaminated. Replace it only with the Hydrophobic Filter available from Arizona Instrument (AZI Part No. 990-0059). When replacing a filter, it is good practice to flush the new filter with dry carrier gas to remove moisture adsorbed to the interior of the filter. After replacing the filter on its holder, replace the top cover before connecting the instrument to its power source. Turn the instrument on and when READY TO TEST appears, run the drydown procedure outlined on page 10 with a clean dry empty sample bottle. When this procedure ends, the system is ready for reuse.

Q: “How do I change the filter?”

A: First, obtain a replacement Hydrophobic Filter, AZI Part Number 990-0059. There should be one in the accessory kit. If none is found, call AZI Customer Service at (800) 528-7411 or (602) 470-1414 for a replacement.

- 1 Remove the power cord from its socket.

CAUTION:

Line voltage is present under the instrument’s cover. To prevent electrical shock, turn off power and remove the power cord when instructed to do so. Do not re-connect the power cord and turn power on until after the cover is secured in place.

- 2 Insert a small probe into the hole at the back of the instrument. It is marked by a graphic symbol indicating the method of opening the top cover, see **Figure 20** on page 38. Push inward to release the safety catch, and lift the top cover up with your free hand. Remove it and put it in a safe place.

- 3 The filter will be found near the right center on top of the manifold assembly. Pull the flex tubing off the top of the filter disk. Rotate the filter disk ½ turn counterclockwise and lift it off. Discard the old filter and replace it with a new one. Reattach the flex tubing. If condensed material is visible in the flex tubing, replace the flex tubing. Note that this is a special type of hydrophobic tubing. The proper tubing is available from AZI as AZI Part Number 345-0050.

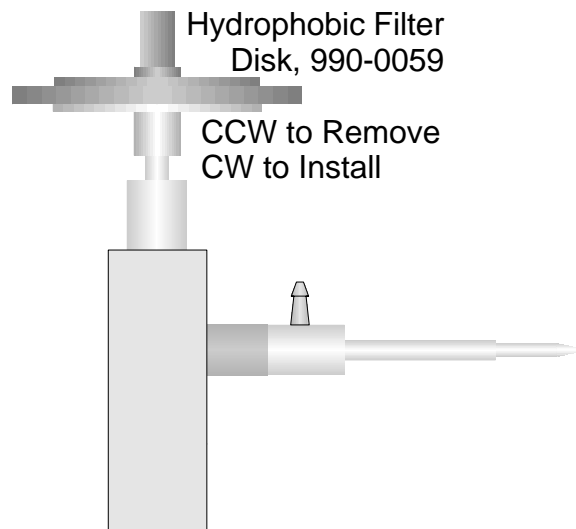

Figure 21 Filter Disk Location

- 4 Replace the top cover and power cord.
- 5 Turn the instrument on and perform a *FILTER DRYDOWN* and a *BOTTLE PURGE,* see page 10.
- 6 When the drying process concludes, the instrument is ready for normal use.

Q: “How do I change the injection port septum?”

A: This is a simple procedure. First, obtain a replacement septum. There should be one in the accessory kit. If none is found, call AZI Customer Service at (800) 528-7411 or (602) 470-1414 for a replacement.

- 1 Turn the instrument off and remove the power cord from its socket.

CAUTION:

Line voltage is present under the instrument’s cover. To prevent electrical shock, turn off power and remove the power cord when instructed to do so. Do not connect the power cord and turn power on until after the cover is secured in place.

- 2 Insert a small probe into the hole at the back of the instrument, (see **Figure 20** on page 38). It is marked by a graphic symbol indicating the method of opening the top cover. Push inward to release the safety catch, and lift the cover up with your free hand. Remove it and put it in a safe place.

- 3 The injection port needle guide will be found near the front center on top of the manifold assembly. Use a 9/16" wrench to loosen the nut. Turn the nut counterclockwise to remove it. Lift off the needle guide and the nut. The septum is now visible at the top of the injection port. Replace it with a new one. Replace the needle guide and nut, hand tightening it. Using the wrench, turn the nut 1/4 turn to load the septum. Grasp the needle guide and make sure everything is properly aligned and secure.

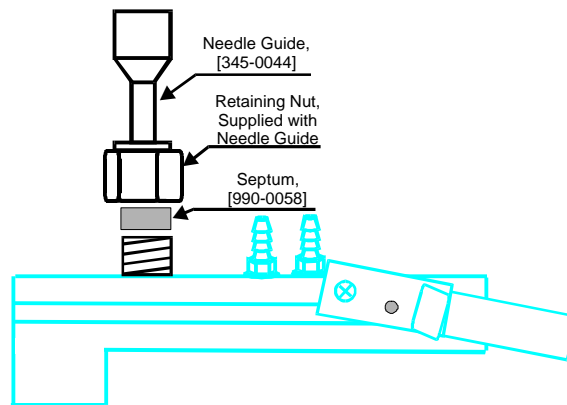

Figure 22 Injection Port Septum Location

- 4 Replace the top cover and power cord.
- 5 Turn the instrument on and the instrument is ready for normal use.

Q: “How do I Calibrate the Flow Sensors?”

A: Follow the steps listed below. A calibrated flow meter that will measure a flow rate of 100 ml/min is required.

- 1 Verify the pressure of the dry-gas supplied to the instrument is between seven (7) and twelve (12) psi. (9 to 10 psi is preferred.)
- 2 Connect the dry-gas supply tube to the Instrument’s Inlet Port.

3 Connect the Instrument’s Outlet Port to a calibrated Flow Meter’s Inlet Port.

4 From the Main Menu, Select in order:

- **Calibration Menu**
- **Edit Cal System Constants**

5 Edit the two values, Flow In and Flow Out, to read 100.

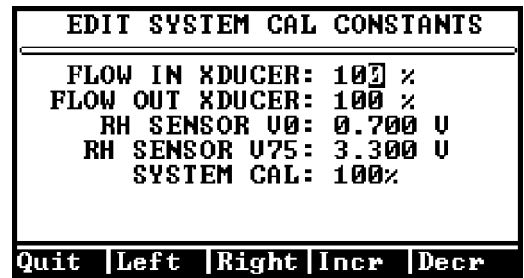

Figure 23 Editing Calibration Value

6 From the Main Menu, Select in order:

- **Diagnostics Menu,**
- **Manual Flow Control,**
 - ▶ BOTTLE PURGE (to allow maximum flow), then
 - ▶ STANDBY (to allow flow regulator adjustment).

7 Turn the instrument off and **remove the power cord from the source of power.**

CAUTION:

Line voltage is present under the instrument’s cover. To prevent electrical shock, turn off power and remove the power cord when instructed to do so. Do not connect the power cord and turn power on until after the cover is secured in place.

8 Insert a small screwdriver or other probe into the latch release hole at the back near the top of the instrument and remove the lid. See **Figure 20** on page 38 for release location. Store the lid in a safe place.

9 Reach through the opening at the top of the instrument and release the two catches at the top rear, inside the instrument. See **Figure 24** for latch locations. This releases the plastic cover from the metal base. Lift the housing up and towards you, and remove it from the chassis. Store the cover in a safe place.

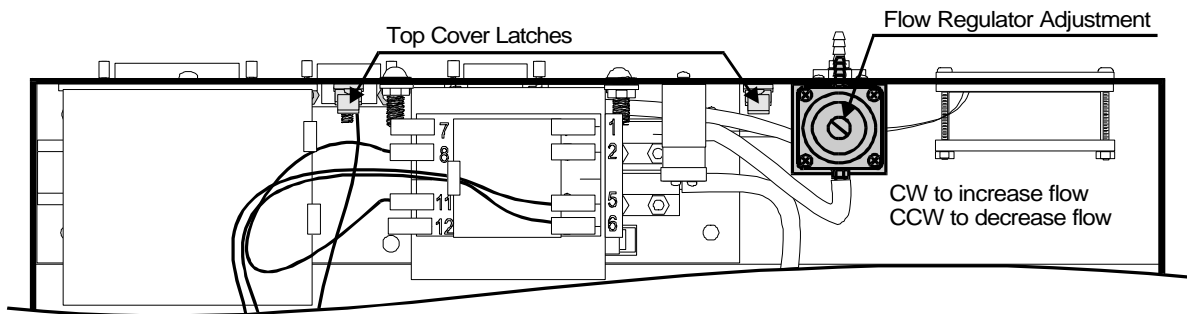

Figure 24 Cover Latches and Flow Regulator Adjustment Locations

- 10 Set the output flow for 100ml/min measured on the flow meter.
 - Slowly Adjust the screw on top of the Inlet Flow Regulator **CLOCKWISE** to increase and **COUNTERCLOCKWISE** to decrease the flow until the flow meter indicates 100 ml/min.

11 Connect the power cord to the source of power and turn the instrument on.

12 Go to the Diagnostics Menu.

13 Select View System Sensor Status

14 Read and record the exact outlet flow rate as indicated by the flow meter.

15 Read and record the instrument's indicated Flow Out from the display.

16 Divide the Measured Outlet Flow Rate by the Instruments Indicated Flow Out and multiply the result by 100 to determine the Flow Calibration Factor (FCF).

SENSOR STATUS		
RH SENSOR:	00.675	% RH
FLOW IN:	113	mL/Min
FLOW OUT:	109	mL/Min
MAN RTD:	068	°C
BOTTLE RTD:	036	°C
RH RTD:	071	°C
H2O FLOW:	0001.1	ug/Sec
FLOW MODE:	STDBY	
Esc	Units	

Figure 25 Sensor Status Display

$$\frac{\text{Measured Flow Out Rate}}{\text{Indicated Flow Out Rate}} \times 100 = \text{Flow Out FCF}$$

16.1 Example: The flow meter reads 100 while the instrument display reads 109 for flow out. The result of 91.7 should be rounded up and a value of 92 used in the next few steps.

$$\frac{100}{109} \times 100 = 91.7$$

- 17 Escape to the Main Menu and select in order:
 - Calibration Menu
 - Edit System Cal Constant

```

EDIT SYSTEM CAL CONSTANTS
-----
FLOW IN XDUCER: 100 %
FLOW OUT XDUCER: 092 %
RH SENSOR U0: 0.700 U
RH SENSOR U75: 3.300 U
SYSTEM CAL: 100%
-----
Quit | Left | Right | Incr | Decr

```

- 18 Edit the Flow Out Transducer % Value to the calculated Flow Out FCF.

- 19 Escape to the Diagnostics Menu.

Figure 26 Editing the Flow Out FCF

- 20 Select View System Sensor Status.
 - Verify that the indicated Flow Out in ml/min now agrees with the measured flow rate on the flow meter within ±1 ml/min.

```

SENSOR STATUS
RH SENSOR: 00.675 % RH
FLOW IN: 113 mL/Min
FLOW OUT: 100 mL/Min
MAN RTD: 068 °C
BOTTLE RTD: 036 °C
RH RTD: 071 °C
H2O FLOW: 0001.1 ug/Sec
FLOW MODE: STDBY
-----
| Esc | Units |

```

Figure 27 Check Indicated Reading

- 22 WHILE AT THE VIEW SYSTEM SENSOR STATUS MENU, Read and record the Flow In value.
- 23 Divide the Indicated Flow Out reading by the Flow In reading and multiply the result by 100 to obtain the Flow In FCF Value.

$$\frac{\text{Indicated Flow Out Rate}}{\text{Indicated Flow In Rate}} \times 100 = \text{Flow In FCF}$$

- 23.1 Example: The instruments flow out reads 100 while the instrument flow in 113. The result of 88.4 should be rounded down and a value of 88 used in the next few steps.

$$\frac{100}{113} \times 100 = 88.4$$

- 24 Escape to the Main Menu and select in order:
 - Calibration Menu
 - Edit System Cal Constant

- 25 Edit the Flow In Transducer % Value to the calculated Flow In FCF.

```

EDIT SYSTEM CAL CONSTANTS
-----
FLOW IN XDUCER: 088 %
FLOW OUT XDUCER: 092 %
RH SENSOR U0: 0.700 U
RH SENSOR U75: 3.300 U
SYSTEM CAL: 100%
-----
Quit | Left | Right | Incr | Decr

```

- 26 Escape to the Main Menu.

27 Select Diagnostics Menu.

27.1 Select View System Sensor Status.

- Verify that the indicated Flow In value agrees with the Indicated Flow Out value within ± 2 ml/min.
- If it does not, Adjust the Flow In FCF value in the Edit System Cal Constant Menu so that the Flow In and Flow Out Indications in the System Sensor Status Menu are equal ± 2 ml/min.

28 Press [Esc] to the Diagnostics Menu.

28.1 Select in order:

- Manual Flow Control
- Off

29 Check and if necessary adjust the RH Sensor calibration, see page 14.

Q: “How do I set up the CT-3000 to use the AZI SP150 or SCI SA800 digital balance?”

A: Follow the steps below.

- 1 Beginning at the Starting Screen, select the prompts in order:
 - Main
 - Setup
 - Ext Balance setup
 - Select Balance Driver



Figure 29 Setup External Balance

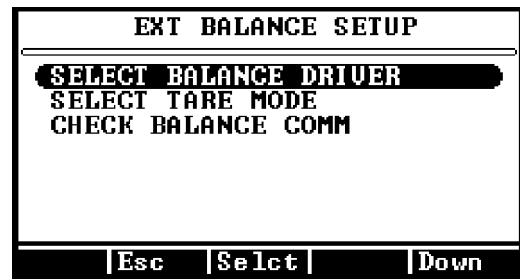

Figure 30 Select Functions

- 2 Select the AZI SP150 or SCI SA800 according to the balance you have.
 - Quit
 - Accept
- 3 Select Tare Mode.
 - Fixed Bottle Weight if all sample bottles weigh exactly the same.
 - Manual Bottle Weight if all bottles are pre-weighed by hand.
 - Tare Empty Bottle if the balance is to tare weigh each bottle before it is filled with sample.

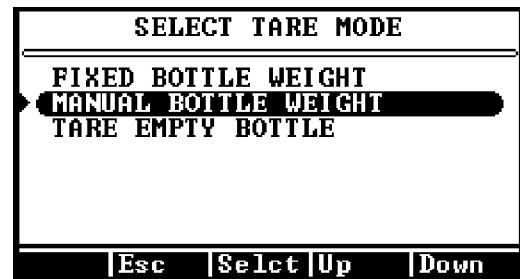

Figure 31 Select Tare Mode

- 4 Escape (ESC) to the Ext Balance Setup Menu.
- 5 Connect the cable between the CT-3000 Balance Input and the balance RS-232 Connector.
- 6 Turn the balance power on and wait for the ready indication.

- 7 Select Check Balance Comm on the Ext Balance Setup Menu.
- Select Go and wait for communication to be established.
 - If the check is bad, verify each step above.

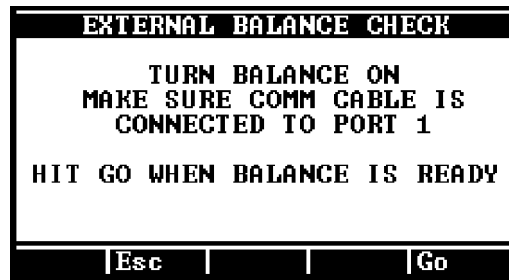

Figure 32 Balance Communication Check

- If the check indicates good communication, a weight will be shown on the CT-3000 display.
- 8 If the check is good, press [Esc] until the Main Test Screen is displayed. If not, recheck the cables and setup conditions.

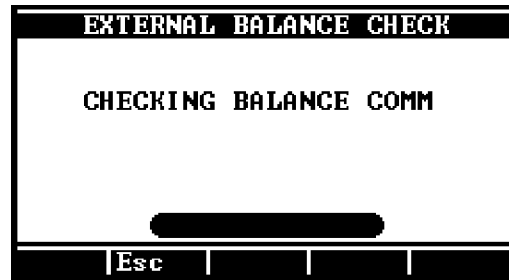

Figure 33 Oval at bottom will show weight when communication good

APPENDIX A - ELECTRONIC BALANCE

Unpacking and Setup

The balance, weighing pans, remote power supply and windscreen are packed in a foam support to protect them from shock during shipping and handling. Save and reuse all packing material for future damage-free shipments.

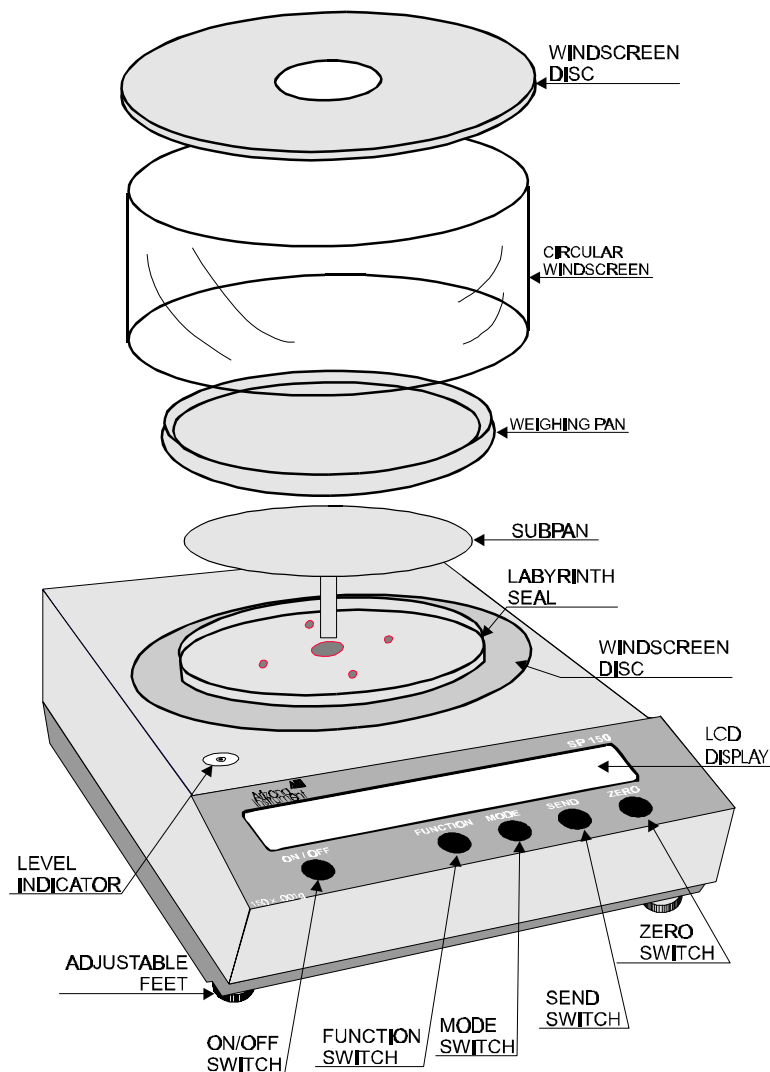

Figure 33 Balance Full View

All AZI balances are equipped with a special clamping screw that locks the balance suspension during shipping. This screw must be loosened before the balance can be operated (see Figure 34).

- Locate the black knob, on the front center of the balance, underneath the display area.
- Remove the paper tag.
- Turn the knob, approximately one (1) turn counter clockwise, as shown in **Figure 34**, until it stops .

If the balance is shipped or moved long distances, the clamping screw should be re-tightened by turning the knob in the clockwise direction until resistance is felt, approximately one (1) turn.

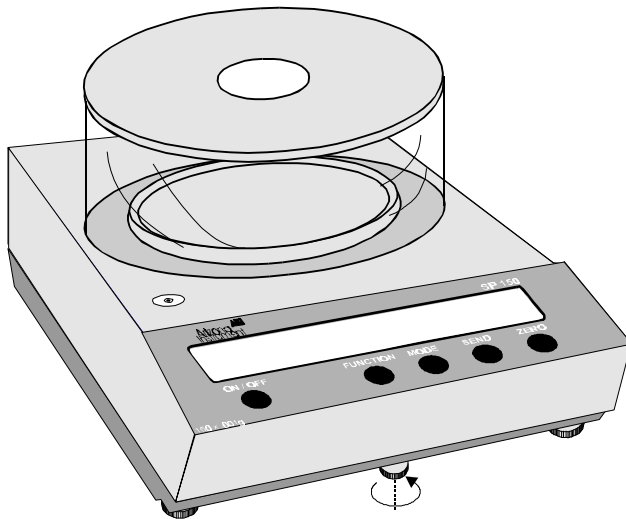

Figure 34 Unlocking Clamping Screw

The environment in which your balance is used is very important. Air movement, temperature changes, vibrations, direct sunlight, etc. influence the performance of high precision balances. Therefore, place your balance on a solid, sturdy surface that is free of air currents and vibration. The surface should not be magnetic and should be located away from doors, windows, heaters, air conditioners and fans.

Level the balance by turning the front feet to center the bubble in the Level Indicator. Turn a foot clockwise to raise that side or counter-clockwise to lower that side of the balance. Turn both feet together to raise or lower the front of the balance.

Before making any connections, verify that the power (VAC) requirement shown on the remote power supply is compatible with the AC power outlet to which the balance will be connected. **First plug the round DIN connector into the rear panel receptacle. Then, plug the power supply into a grounded AC outlet. Do not alter or bypass the ground plug in any way. Doing so adversely affects the performance of the balance.**

NOTE: Your balance must be plugged in and switched on for at least one (1) hour, then calibrated, prior to use. Please see the calibration instructions on page 52.

The On/Off Switch

Press the ON/OFF switch and observe the turn on sequence shown below.

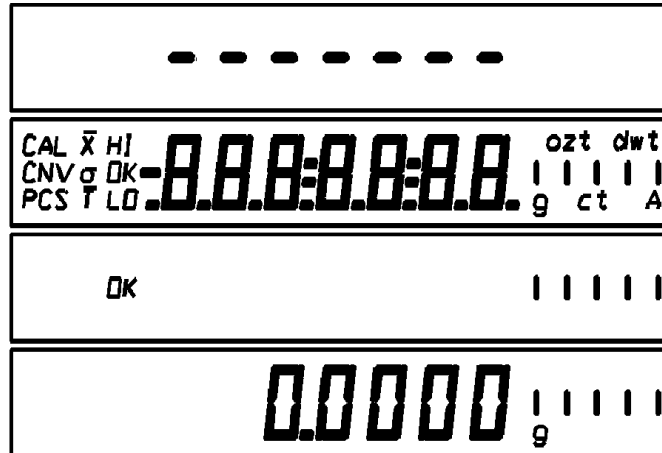

Figure 35 Turn On Display Sequence

During this sequence the balance is doing an automatic systems checkout to verify it is functioning properly.

Connecting the External Balance to the Computrac 3000

The SP150 balance is configured to interface directly with the Computrac 3000 Moisture Analyzer. Weight readings at the balance can be transmitted directly to the Computrac 3000 through the null modem cable connection.

To enable this communication between the balance and the Computrac 3000:

- 1 Power to both units should be switched OFF.
- 2 Connect the SPECIAL null modem cable (AZI p/n 200-0069) to the RS-232 connector at the rear of the SP150 balance. Connect the other end of the cable to the balance connector at the rear of the Computrac 3000.
- 3 Switch the power to both units ON.
- 4 On the Computrac 3000, press the Menu key. Use the down arrow key to highlight the SETUP MENU. Press the Selct key to access this menu. Highlight the EXT BALANCE SETUP option, and use the EDIT key to select “Computrac” as the external balance. Press the Accept key to program this option change. Select the Comm Check option to verify the cable is connected. Use the **[Esc]** key to return to the MAIN MENU.
- 5 At the MAIN MENU, select the Add/Edit Memory Start menu. Access the memory start to be edited using the up or down arrow keys and the Select key. At the Sample Weight Entry Mode option, select the option Digital Balance.

When a test is run using that memory start parameter, the Computrac 3000 will automatically check for data communication. The weight readings from the external balance will be displayed on the Computrac 3000 display. Follow the display prompts to proceed through the weighing and testing sequence.

The Zero Switch

Pressing the ZERO switch at any time returns the display to zeros. When a weighing that has been zeroed out is removed from the pan, a negative reading is displayed. To return to zeros, press the ZERO switch.

Unit of Weight Selection

Pressing the MODE switch starts the unit of weight cycle as follows: grams (g), carats (ct), pennyweights (dwt), troy ounces (ozt), and ounces (oz). Press the MODE switch a second time when the desired unit of measure appears. For Computrac 3000 operation, verify that the balance is weighing in grams (g).

The Send Switch

Pressing the SEND switch sends the information on the display to the Computrac 3000.

The Function Switch

Pressing the FUNCTION switch cycles the display through four functions as follows:

- PCS - front panel parts counting
- HI OK LO - check weighing
- CAL 1 - auto-calibration
- CAL 2 - factory set - do not use

To access the desired function, press the MODE switch when it appears on the display.

CAL 2 is set at the factory and should never require further adjustment. The procedures for the other three functions are as follows:

Auto-Calibration (CAL 1) - Using an External Calibration Weight

Perform auto-calibration every time you move your balance. It is extremely important to use high quality weights and verify the balance has been warmed up for at least one (1) hour prior to calibration.

Procedure	Display Reading
Remove any containers or weighings so that only the stainless steel pan is in place. Press the ZERO switch.	Zeros are displayed.
Press the FUNCTION switch.	Display cycles repeatedly through PCS, HI-OK-LO, CAL1, CAL2.
Press the MODE switch when CAL 1 appears.	CAL 1 and a flashing O are displayed.
Wait 10 seconds then press the ZERO switch.	The display stops flashing. In approximately 10 seconds a weight value or two alternating weight values flash on the display.
Place the displayed weight or one of the alternating weights on the pan.	The display stops flashing and the selected weight is displayed.
Wait 10 seconds then press the ZERO switch.	The weight continues to be displayed while the calibration takes place (approximately 10 seconds). The display blanks, then displays "OK" and then displays the calibration weight.
Remove the calibration weight.	The display returns to zeros and the normal weighing mode.

RS-232 Front Panel Configuration

The RS-232 Configuration Mode allows changes to the baud rate, front panel control, software protocol, parity and auto send. The balance is configured at Arizona Instrument to communicate with a Computrac 3000. AZI preset settings indicated in the following table by parenthesis around the setting. Any changes to this configuration will affect communication with the Computrac 3000.

It is not necessary to follow the entire configuration procedure if only one parameter is to be changed. Follow steps 1 and 2, then use the MODE switch to select the parameter to be changed, skipping the others. Select the desired setting using the SEND switch, save the setting using the ZERO switch, then turn the balance off and then on again with the ON/OFF switch.

To enter RS-232 configuration mode proceed as follows:

Procedure	Display Reading
Turn balance off using the ON/OFF switch.	Display blanks.
Hold the SEND switch down while turning balance on using ON/OFF switch.	OK and the current baud rate, br300, br600, br1200, br2400, br4800, br9600 or br19,200 is displayed.
BAUD RATE SELECTION (9600 is default)	OK SAVED is displayed followed by OK and the chosen baud rate.
Press the SEND switch until the desired baud rate is displayed, then press the ZERO switch.	
LOCAL CONTROL SELECTION, via front panel, (LC OFF is default.) Press the MODE switch.	OK and the current front panel control setting, LC on or LC off is displayed.
Press the SEND switch to choose off , then press the ZERO switch.	OK SAVED is displayed followed by OK and the chosen setting.
PROTOCOL SELECTION (Pr OFF is default.) Press the MODE switch.	OK and the current software protocol setting, Pr off or Pr on is displayed.
Press the SEND switch to choose off , then press the ZERO switch.	OK SAVED is displayed followed by OK and the chosen setting..
PARITY SELECTION (PA nonE is default.) Press the MODE switch	OK and the current parity setting, PA EVEN, PAodd or PA nonE is displayed.
Press the SEND switch to choose nonE , then press the ZERO switch.	OK SAVED is displayed followed by OK and the chosen setting.

Procedure

AUTO SEND SELECTION (AS oFF is default.) Press the MODE switch.

Press the SEND switch to choose **off** then press the ZERO switch.

CONTINUOUS SEND SELECTION (CS oFF is default.) Press the MODE switch.

Press the SEND switch to choose **off**, then press the ZERO switch.

DISPLAY BLANKING SELECTION (bL oFF is default.) Press the MODE switch.

Press the SEND switch to choose **off**, then press the ZERO switch.

Press the ON/OFF switch

Display Reading

OK and the current auto send setting, AS oFF or AS on is displayed.

OK SAVEd is displayed followed by OK and the chosen setting.

OK and the current continuous send setting, CS oFF or CS on is displayed. The display blanks.

OK SAVEd is displayed followed by OK and the chosen setting.

OK and the current display blanking setting, bL on or bL oFF is displayed

OK SAVEd is displayed followed by OK and the chosen setting.

The display blanks.

APPENDIX B - SPECIFICATIONS AND RATINGS

These specifications are intended as a guide to proper use of the instrument. Specifications and features will vary with application. AZI product specifications are controlled by ISO-9001 procedures and are established and verified during design. They are not to be construed as test criteria for every application. Refer to AZI document Number 4C04-0001 for current specifications controlling this instrument. All specifications and features are subject to change without notice. Periodically contact Customer Service to see if any upgrades are available for your instrument.

Dimensions:	Approximately 146 mm X 380 mm X 370 mm
Weight:	Approximately 8.6 kg (19 lbs)
Power Ratings:	110 \pm 10% volts 50/60 Hz, 1 amp standby or 8 amps heat on, or 210 \pm 10% volts 50/60 Hz, 0.5 amp standby or 4 amps heat on,
Environmental Requirements:	5 to 40 $^{\circ}$ C, 0 to 80% RH, non-condensing, indoor use. Optimum results are obtained from 20 to 40 $^{\circ}$ C.
Heating Range:	25 $^{\circ}$ C to 275 $^{\circ}$ C, electronically controlled
Resolution:	1 microgram, 1 ppm, 0.0001% water in sample
Special Service Carrier Gas:	Dry nitrogen or dry air (-40 $^{\circ}$ C dew point, or lower is suggested) at 7 to 12 psig, user supplied.
Rear Panel Connections:	Parallel printer port (PC standard) 9 pin RS-232 (9600,N,8,1) 9 pin Balance Comm (proprietary protocol and cable) Power cable receptacle with RFI filter Carrier gas input barb fitting Carrier gas exit barb fitting
Side Panel Connections:	PC keyboard DIN socket
Detection Limit:	10 micrograms (1 standard deviation)
Repeatability:	Depends on sample properties and syringe technique, typically CV is <10%.
Accuracy:	Depends on sample properties and syringe technique, typically error is <10%.
Automatic Test Ending Method:	Rate Threshold, user adjustable Time, user adjustable Prediction

Accessory Kit:	One 1.0 microliter calibrated syringe	990-0068
	Ten each 20 milliliter sample bottles with septa and caps	990-0064
	One hydrophobic filter	990-0059
	Two injection port septa	990-0058
	Replacement sample probe	990-0057
	User's Manual	700-0012
	Power cord for 120 volt use	200-0002

Optional	101 key PC keyboard	990-0088
Accessories:	PC graphics printer	Y990-0098
	Digital balance with cable and Communications Software	Y990-0082
	Travel case	990-0092
	Dry air generator	600-0169

Warranty: Instrument is warranted for two years against defects in material or workmanship. Consumable and routine maintenance are not included in the warranty. Contact Customer Service for AZI annual maintenance contract information.

US Patent No. 5,712,421
 Foreign Patents Pending
 UL and CE Listings Pending

TRADEMARK AND COPYRIGHT PROTECTION

Computrac, Arizona Instrument, and the stylized AZI are all registered trademarks of Arizona Instrument LLC. Instrument firmware is copyright protected.

Copyright 1998, Arizona Instrument LLC. All Rights Reserved.

Arizona Instrument LLC
Computrac 3000 Moisture Analyzer User Manual
Part Number: 700-0012
Revision C1
Document Number 6C21-0017
February, 1998

If you have any questions regarding the operation of this instrument, please call our toll free number (800) 528-7411 or fax (602) 470-1888. Internationally, call (602) 470-1414 or from Canada call (800) 528-7411.

Arizona Instrument
3375 N Delaware St
Chandler, AZ 85225 USA
<http://www.azic.com>
email:
azi@azic.com - General
intl@azic.com - International
support@azic.com - Customer Support