



ARIZONA INSTRUMENT LLC

Computrac® MAX® 2000XL MOISTURE ANALYZER USER'S MANUAL

**Firmware Revision 4.36
March 2009**

Arizona Instrument LLC
3375 N Delaware Street
Chandler, AZ 85225
(602) 470-1414
(800) 528-7411
<http://www.azic.com>
e-mail:
azi@azic.com - General
intl@azic.com - International
support@azic.com - Customer Support

AZI P/N 700-0104-B

TABLE of CONTENTS

1.	WARNINGS AND SAFETY INFORMATION	6
2.	PACKING and SHIPPING INSTRUCTIONS	8
2.1.	MAX [®] 2000XL PACKING DIAGRAM	9
3.	INTRODUCTION	10
4.	INSTRUMENT DESCRIPTION	11
4.1.	Hardware	11
4.2.	Heating System	11
5.	INSTRUMENT SETUP	12
5.1.	Instrument Location	12
5.2.	Interior of Test Chamber	13
5.3.	AC Power Connection	14
5.4.	Controls	15
5.5.	Login	17
5.6.	Setting Calibration Prompts	18
5.7.	Calibrate Balance - 20 gram weight required	19
5.8.	Verify Balance	20
5.9.	Weight Test - three and five gram weights required	21
5.10.	Connecting Nitrogen Purge Kit - AZI P/N 990-0046	22
5.11.	Connecting a Printer	24
5.12.	Connecting a Computer	26
5.13.	MAX [®] 2000 Communication Software	26
5.14.	Test Procedure	27
5.15.	Test Data Output	28
6.	MENU SYSTEM: Instrument Configuration And Operation	29
6.1.	MAIN MENU	30
6.2.	Memory Start Menu	31
➤	Add/Edit Memory Start	31
⇒	Sample Name	31
⇒	Temperatures	32
	Test Temperature	32
	Test Hstart Temperature	32
	Idle Temperature	32
	Start Temp Control	32
➤	Ending Criteria	33
⇒	End Test on Prediction	33
	Auto Criteria Selection	33
	Manual Criteria Selection	33
⇒	End Test on Rate	34
⇒	End Test on Time	34
➤	Sample Size Options	34
⇒	Sample Size	34
⇒	Sample Window	34
⇒	Inside Limits and Outside Limits	35
➤	Tare Options	35
⇒	Pan Tare Options	35
⇒	Sample Tare Option	36
⇒	Special Options	37
➤	Result Display Options	37
➤	Lift Comp Pct	37

➤	Linked Test Options	38
➤	Reorder Memory Start.....	39
➤	Delete Memory Start	39
➤	Print Memory Start.....	39
6.3.	STORED DATA (Not available on 21 CFR, Part 11 compliant instruments) ...	40
➤	View Stored Data	40
➤	Analyze Stored Data	40
➤	Print Stored Data	41
➤	Delete Stored Data	41
6.4.	CALIBRATION MENU	41
➤	Balance Calibration Menu.....	41
➤	Temperature Calibration	43
6.5.	SETUP MENU	46
➤	Printer Setup.....	46
➤	Report Setup.....	46
➤	Report Control Options	46
➤	Report Items to Print	46
➤	Enter/Edit Company Name	47
➤	Clock Setup	47
➤	Data Format Setup.....	47
⇒	Ending Criteria Display (EC DISPLAY:)	47
⇒	Lot Number and Product ID (LOT NUMBER:)	47
➤	Access Key Setup.....	48
➤	Login Setup	48
➤	TDLTO.....	49
➤	30 Day	49
➤	Balance Mode.....	49
➤	Foil Weight Setup	49
7.	MEMRY - Memory Start Selections.....	50
8.	GRAPH: Displaying the Moisture Trend Plot	50
9.	PARAM: Temporarily Changing Test Parameters	51
10.	MISCELLANEOUS MESSAGES.....	51
10.1.	Control Program Version Number	51
10.2.	Diagnostic Failure Messages.....	52
11.	PERFORMANCE ENHANCEMENT.....	53
11.1.	Selection of Test Temperature	54
11.2.	Selection of Ending Criteria.....	55
11.3.	Preparing Granular and Powdery Samples.....	55
11.4.	Preparing and Testing Liquid Samples	56
11.5.	Selecting the Optimum Sample Size	56
12.	PERFORMANCE VERIFICATION	57
12.1.	The Weight Test	57
12.2.	The Precision Weight Test	57
12.3.	Sodium Tartrate Test.....	58
12.4.	Precision Tartrate Test	59
12.5.	Retained Samples	60
13.	ROUTINE MAINTENANCE.....	61
13.1.	Chamber Interior	61
13.2.	Heater Cleaning.....	61
13.3.	Sample Pan Support	62
14.	TROUBLE MESSAGES	63

15.	TROUBLE DIAGNOSIS.....	64
16.	SPECIFICATIONS	67
17.	ACCESSORIES & MAINTENANCE PARTS	69
18.	APPENDIX A - DRIFT TEST.....	70
19.	WARRANTY.....	72
20.	MAINTENANCE CONTRACT	73
21.	TRADEMARK AND COPYRIGHT PROTECTION.....	73

1. WARNINGS AND SAFETY INFORMATION

The MAX[®] 2000XL Moisture Analyzer complies with the Underwriter Laboratories Inc. standards and European Council Directives for Electrical Equipment for Laboratory Use, electromagnetic compatibility, and the stipulated safety requirements. However, improper use or handling of instrument can result in damage to equipment and/or injury to personnel.

The MAX[®] 2000XL Moisture Analyzer is identified as Equipment Class I, Pollution Degree 2, and Installation Category II.

Read this manual thoroughly before using your moisture analyzer to prevent damage to the equipment. Keep these instructions in a safe place. An up-to-date electronic copy of this manual can be found at the Arizona Instrument (AZI) web site at <http://www.azic.com/downloads.aspx>.

The following instructions will help to ensure safe and trouble-free operation of your moisture analyzer.

- Use the moisture analyzer only for performing moisture analysis of samples. Any improper use of the analyzer can endanger persons and may result in damage to the analyzer or other material assets.
- Do not use this moisture analyzer in a hazardous area/location; operate it only under the ambient conditions specified in these instructions.
- Although the moisture analyzer is simple to operate and is very user friendly, it should only be operated by qualified persons who are familiar with the properties of the sample being analyzed.
- Ensure, before getting started, that the voltage rating printed on the manufacturer's label is identical to your local line voltage (see the section beginning on page 14.)
- The MAX[®] 2000XL Moisture Analyzer is provided with a power cord that has a protective grounding conductor. Do not operate the unit without the supplied three-wire power cord or an identical, recognized equivalent that meets all applicable standards.
- AZI does not recommend the use of an extension cord. However, if one must be used, use an extension cord that meets all applicable standards and has a protective grounding conductor.
- Do not remove the protective grounding wire from the power supply circuit.
- With the power switch off, power is still applied to the power entry module. Disconnect the power cord from the instrument to ensure complete power removal.
- Position the power cable so that it cannot touch any hot areas of the moisture analyzer.

- Use only AZI-supplied accessories and options with the MAX[®] 2000XL Moisture Analyzer or check with AZI before using any third party accessories, such as printers and analytical balances, to verify compatibility.
- If there is visible damage to the MAX[®] 2000XL Moisture Analyzer or its power cord, unplug and isolate the unit first and then call AZI Customer Service at 1-602-470-1414.
- Do not open the analyzer housing of the MAX[®] 2000XL Moisture Analyzer. There are no user serviceable parts or adjustments inside the unit. Any maintenance inside the unit is to be performed by factory-trained technicians only. Any unauthorized inspection and/or maintenance of the MAX[®] 2000XL Moisture Analyzer will void the warranty.

Prevent excess heat build-up around the analyzer

- When setting up the MAX[®] 2000XL, leave enough space to prevent heat from building up and to keep your analyzer from over-heating. Leave 20 cm (about 8 inches) around the moisture analyzer and 1 meter (about 3 ft.) above the unit.
- Do not put any flammable substances on, under or around the moisture analyzer.
- Use extreme care when handling the used sample pan when removing it from the unit. Although the pans cool rapidly, they are still very hot when the lid is first opened after a test.

HAZARDS FOR PERSONS OR EQUIPMENT POSED BY USING SPECIFIC SAMPLES:

Flammables; explosives; substances that contain flammables, explosives, solvents; and/or substances that release flammable or explosive gases or vapors during the drying process.

- If flammable or explosive liquids are tested, the gases escaping from the unit are still dangerous when they are exposed to the atmosphere. Fume hoods may offer partial protection but the potential danger will still be present. The user shall be liable and responsible for any damage that arises in connection with the MAX[®] 2000XL Moisture Analyzer and potentially harmful substances.
- Substances containing toxic, caustic or corrosive substances may be analyzed with the unit in an appropriate fume hood only. The fume hood must keep the work area below the lower toxic limit established by appropriate standards.

- Substances that release caustic vapors, such as acids, should be analyzed in the smallest sample size possible to still achieve satisfactory results. If vapors condense on the MAX[®] 2000XL Moisture Analyzer's housing parts, stop the testing, wipe the surface clean with a suitable neutralizer and place the unit in a fume hood capable of removing the vapors. The instrument is composed of powder coated aluminum, anodized aluminum, and some brass fittings. Check for compatibility of substances to be tested before inserting them into the instrument.
- The user has the responsibility for carrying out appropriate decontamination if hazardous material is spilt on or inside the MAX[®] 2000XL Moisture Analyzer.

CLEANING

- Clean the MAX[®] 2000XL Moisture Analyzer according to the cleaning instructions only. Use of strong detergents and "oven cleaners" will damage the case and heater housing.
- Before using any cleaning or decontamination method, except those recommended by Arizona Instrument, check with AZI Customer Service at 1-602-470-1414 or 1-800-528-7411, to ensure that the proposed method will not damage the equipment.
- The outside housing of the MAX[®] 2000XL Moisture Analyzer should be cleaned with a mild household detergent such as "409" and a soft, lint-free cloth. Paper towels should never be used, as they will scratch the instrument's finish and the clear lens over the display. If methods that are more stringent are required, call AZI Customer Service at 1-602-470-1414 or 1-800-528-7411 for recommendations.
- Every precaution has been taken to prevent contaminants from entering the unit. However, if liquids or powders do enter the case, call AZI Customer Service at 1-602-470-1414 or 1-800-528-7411 for recommendations.

The user shall be liable and responsible for any damage that arises in connection with the use of this moisture analyzer.

ENVIRONMENTAL CONDITIONS

Storage and Shipping

- Temperature should be between 0 °C to +40 °C (+32 °F to +104 °F).
- Relative Humidity should be between 10% and 80%.

OPERATIONAL CONDITIONS – INDOOR USE.

- Optimum results will be achieved when the unit is set on a smooth, level, non-vibrating surface in a non-condensing, non-explosive environment of 0-40 °C @ 50% relative humidity and 0-31 °C @ 80% relative humidity.
- Do not expose the moisture analyzer unnecessarily to extreme temperatures, moisture, shocks, blows or vibration.

UNPACKING THE MOISTURE ANALYZER

- After unpacking the moisture analyzer, check it immediately for any visible damage resulting from rough handling during shipment.
- Save the box and all parts of the packaging to use when returning your moisture analyzer for calibration. Only the original packaging provides the AZI-recommended protection for shipment. Before packing your moisture analyzer for shipment, unplug all connected cables to prevent damage during transit.

WARNING SYMBOLS



- Protective Ground

Identifies the connection on the Chassis and Power Inlet Module for connection of the safety ground (green/yellow) wire.



- Warning

Information or procedures that must be observed.



- Electrical Shock Hazard.

Observe all steps of the procedure to prevent electrical shock.



- Warning, Hot surface or area of possible severe burns.

Use listed precautions when opening the oven lid and handling samples to prevent injury.

2. PACKING AND SHIPPING INSTRUCTIONS

IMPORTANT

Movement, handling, and packaging of the instrument must be done with EXTREME CARE to avoid permanent, expensive internal damage. The MAX[®] 2000XL uses a delicate and very sensitive electronic force balance to measure small weights and weight losses. The balance is capable of measuring weight to a resolution of 0.1 milligram, over a sample weight range from 150 milligrams to 40 grams. Careful handling is necessary to prevent damage to the balance. With proper care, the instrument will provide years of dependable service.

UNPACKING

Unpack the instrument carefully and set it down gently. Select a place where it will be safe from bumping, jarring, excessive air currents, and vibration.

Retain all packaging materials for any future shipment of the instrument. If the instrument is returned to AZI for any reason, it must be placed in the original packaging materials, which have been tested and proven to be effective protection during shipment. See page 9.

REPACKAGING FOR SHIPMENT

- Call AZI Customer Service at 1-800-528-7411 or 1-602-470-1414 for Return Material Authorization (RMA) information prior to returning a unit.
- For all shipments, boxes and packing materials are available from AZI.
- Pack the MAX[®] 2000XL in a Computrac[®] MAX[®] 2000XL shipping container, using the packing figure supplied on the box as a guide.
- Be sure to place the foam block underneath the pan support when packing the instrument. See page 13 for pictures and more information.

**AZI WILL NOT BE RESPONSIBLE FOR SHIPPING DAMAGE.
IF YOU RETURN THE INSTRUMENT IMPROPERLY PACKAGED OR SHIPPED YOU
SHOULD INSURE IT FOR FULL VALUE.**

2.1. MAX[®] 2000XL PACKING DIAGRAM

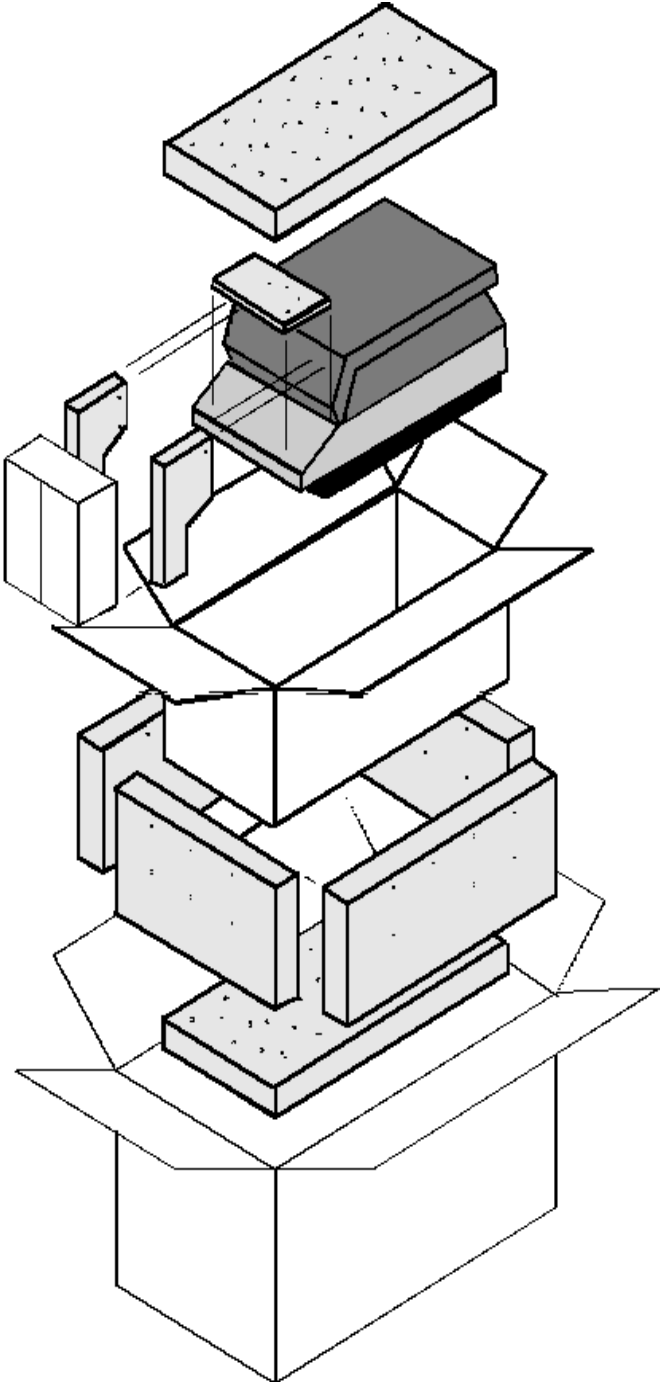

3. INTRODUCTION

The Computrac[®] MAX[®] 2000XL, manufactured by Arizona Instrument LLC of Chandler Arizona, is a high performance programmable moisture analyzer. It uses the proven loss-on-drying method to detect the volatile content of a sample of test material. The instrument may be programmed to use Arizona Instrument's pioneering prediction method of automatically ending a test to provide accurate results in the shortest possible time.

Typically, the instrument results are precise to better than:

20% CV*	from	0.005% - 0.010%
10% CV	from	0.010% - 0.100%
2.0% CV	from	0.100% - 100%
* CV	=	Coefficient of Variation

The accuracy of the MAX[®] 2000XL is maintained by periodic balance and temperature calibrations performed by the operator or quality assurance and by annual factory calibration. The MAX[®] 2000XL also includes a balance linearity verification feature, allowing verification of the linearity of the balance across the balance's full range. In addition, the MAX[®] 2000XL has the capability to be used as a regular high-precision balance when not being used to analyze samples for moisture.

The MAX[®] 2000XL will test at temperatures from 25 °C to 275 °C set at increments of one degree. The advanced heat control program brings the sample up to temperature in less than three minutes. Depending on the rate of volatilization of the sample moisture, test results are available in as little as two minutes, twice as fast as older instruments of this type.

The instrument is programmable through the easy-to-use front panel menu system. For plant control purposes, the programming features can be placed under access code control, preventing unwanted changes to operating parameters. For additional tracking and control, a user must be logged into the MAX[®] 2000XL before any testing can be done. Advanced computer circuitry enables the instrument to be programmed with test parameters for 244 different materials in addition to the two factory set test parameters, Tartrate and weight tests, and one rapid change set for parameter development. On-board memory allows selective analysis of mean, standard deviation and coefficient of variation of tests from up to 108 stored test results for X-bar reports.

Test data can:

- Be stored in the instrument,
- Be sent directly to a personal computer,
- Be printed on many graphics-capable printers, and may include a printed graphical representation of the drying process.

4. INSTRUMENT DESCRIPTION

4.1. Hardware

The MAX[®] 2000XL consists of a small convection air oven, a weighing mechanism with a resolution of 0.1 milligrams and a full scale range of 40 grams, and a backlit, graphic Liquid Crystal Display (LCD). A microprocessor controls the test process, data handling, communications, and performs all necessary calculations. A small fan in the lower chassis maintains the electronics at a stable, low temperature. Connectors for a printer and serial communications devices are provided at the back. The power input module can be set for either 100-120 volts or 220-240 volts (see page **14**).

The MAX[®] 2000XL is designed to remain powered up at all times. When it is not in use, keep the lid down. The light behind the LCD will turn off after a period of inactivity to conserve energy. The display is visible but appears very dim. Press any key to restore the backlight to illuminate the LCD.

4.2. Heating System

The sample heating system is designed to remove volatile components from the sample as quickly as possible, while maintaining accurate temperature control to prevent sample degradation. Oven temperature is measured with a Resistance Temperature Device (RTD), mounted in a rugged metal tube to prevent damage and dislocation. Temperature control accuracy is within one degree of the set value after equilibrium is reached. The 700-watt heater reaches equilibrium in 90 to 180 seconds, depending on the difference between the starting and setpoint temperatures. Closed loop feedback control assures a constant temperature even if power line voltage varies during the test. The heating system is automatically turned off when the test is completed. **Open the lid to speed cooling before performing the next test, if needed.**

For those familiar with moisture analysis instruments, the MAX[®] 2000XL should be simple to operate. Section **5. INSTRUMENT SETUP** on page **12** gives the instrument setup and calibration instructions for those who have used Computrac[®] instruments before. Section **6 MENU SYSTEM: Instrument Configuration And Operation** on page **29** describes the instrument's menus and how to select options. If you are unfamiliar with this technology, **please read all of the sections in this manual before attempting your first analysis.**

5. INSTRUMENT SETUP

Call AZI customer service or your technical sales representative at 1-800-528-7411 or 1-602-470-1414 if you have any questions about the following instructions. You may also contact customer service by e-mail at support@azic.com. Updated revisions to this manual are available at the AZI web site. Log onto <http://www.azic.com/downloads.aspx> and scroll down for a list of available manuals.

5.1. Instrument Location

- Select a location for the instrument that is:
 - Firm and level,
 - Free from vibration that will affect the balance measurements,
 - Close to an isolated power outlet that will provide dedicated electrical power, and
 - Away from the direct flow of a fan or heating/air-conditioning outlet that might produce force on the balance.

Please save the shipping box and all packaging materials for future use.

- Carefully unpack the instrument and locate the following items:

Part Name	AZI Part Number		
MAX [®] 2000XL	MAX 2000XL	MAX 2000XL -220V	
Advantage Upgrade (v4.36)	710-0052		
Accessory Kit	Y990-0131		
Line Cord (Varies with area)	USA/Canada	England	Europe
	200-0002	200-0003	200-0008
Sample Pans: Waffle	990-0008		
Test Weights: 3 grams	690-0003		
5 grams	690-0004		
20 grams	690-0007		
Tweezers	690-0012		
User's Manual	700-0104		
Optional Accessories			
Printer Kit	Y990-0098		
RS-232 Cable - null modem for computer interface	6000-1044		
Temperature Calibration Kit – 110V	Y990-0156		
Temperature Calibration Kit – 220V	Y990-0160		
Sample Pans: Flat	990-0010		
Filter Paper	990-0003		
Outer Shroud Gasket – Needed for testing at less than 0.5% moisture.	300-0114		
Shipping Container	751-0008		
Nitrogen Purge Kit	990-0046		

5.2. Interior of Test Chamber

- Open the lid by lifting the handle just above the display.
- Remove the yellow tape, pan support and packing foam.
- Save the foam so that it can be taped in place when the instrument is returned to the factory for annual calibration.
- Install the pan support gently but firmly into the instrument.



CAUTION - Do not, at any time, attempt to spin the pan support as it may result in damage to the force balance. Avoid excess pressure from the top or sides, which can damage the force balance.

NOTE: The Outside Shroud Gasket is not used in all applications and may not be included with your instrument.

Check the clearance between the pan support arms and the inside shroud gasket by observing the space between the arms and the shroud gasket. The clearance should be about one millimeter, or about the thickness of an American dime. If the clearance is considerably different from one millimeter, remove the pan support from the instrument and adjust the height using the included Allen wrench to loosen the set screw in the center of the pan support. Rotate the pan support to the correct height, then re-tighten the set screw and reinstall the pan support. For assistance, or if the pan support appears to be crooked, call AZI customer service or your technical sales representative at 1-800-528-7411 or 1-602-470-1414.

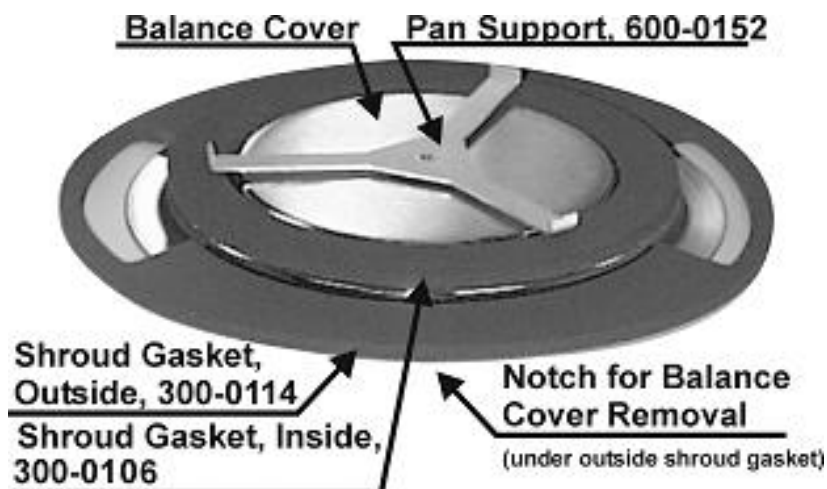



Ensure the AC power receptacle is set for the correct voltage (110 or 230 VAC). The MAX[®] 2000XL will draw up to eight (8) amps. Ensure the instrument is provided with its own **DEDICATED and GROUNDED** electrical power outlet. Do not put it on a circuit with motors, blenders, heaters, coolers, grinders, or other high-current electrical devices.



5.3. AC Power Connection

- The MAX[®] 2000XL can be used with either 100-120 or 220-240 VAC. Check the setting on the power entry module, located at the rear of the instrument, for the correct voltage (100-120 or 220-240 volts) from your power receptacle.
- To change from 110 to 220VAC, or from 220 to 110VAC:
 - Pry the fuse holder from the power entry module using a small flat screwdriver.
 - Change the fuse:
 - A unit operating from 100-120 VAC should have eight (8) amp slow blow fuses, (AZI P/N 190-1001).
 - A unit operating from 200-240 VAC should have four (4) amp slow blow fuses, (AZI P/N 190-1002).
 - Rotate the fuse holder 180° and reinstall it in the power entry module, making sure that the arrow on the power entry module is pointing to the correct voltage for your environment.
 - Ensure the power switch, located next to the fuse holder, is in the off (O) position.
 - Remove the power cord from the packing material and insert the rectangular end into the power receptacle, located on the other side of the fuse holder.



The power source outlet used by the MAX[®] 2000XL **MUST BE GROUNDED**. (If you are not sure if the socket is grounded, check with your plant electrician before proceeding). **The MAX[®] 2000XL will appear to function correctly even if the socket is not grounded, but there is a danger of possible electrocution! If grounded outlets are not available, consider using a ground fault interrupter to protect personnel against electrical shock.**



- Plug the line cord into its dedicated electrical power outlet. Line noise on the power lines may affect accuracy. A dedicated AC power line or an isolation transformer for the MAX[®] 2000XL may be beneficial in eliminating this noise.
- The MAX[®] 2000XL is designed to remain powered up at all times. Turn the instrument on by pressing the switch on the back of the analyzer above the power receptacle and the opening screen will appear.

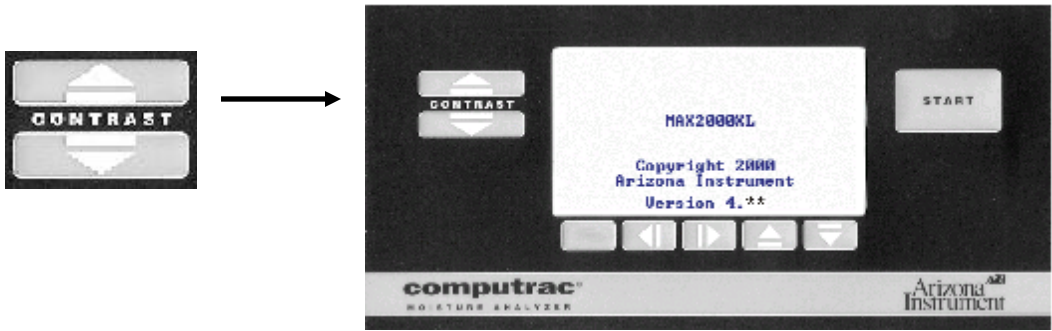

MAX[®] 2000XL Opening Screen
 (** Your specific firmware version is shown here)

- Adjust the contrast controls on the analyzer’s front panel as necessary to view the screen display.
- Before beginning any test, allow the instrument to warm up for 30 minutes.

5.4. Controls

- The front panel controls consist of two arrow keys at the left used to adjust the display [CONTRAST]; five small keys below the display labeled [], [◀], [▶], [▲], and [▼]; and a large [START] key at the right side of the panel.

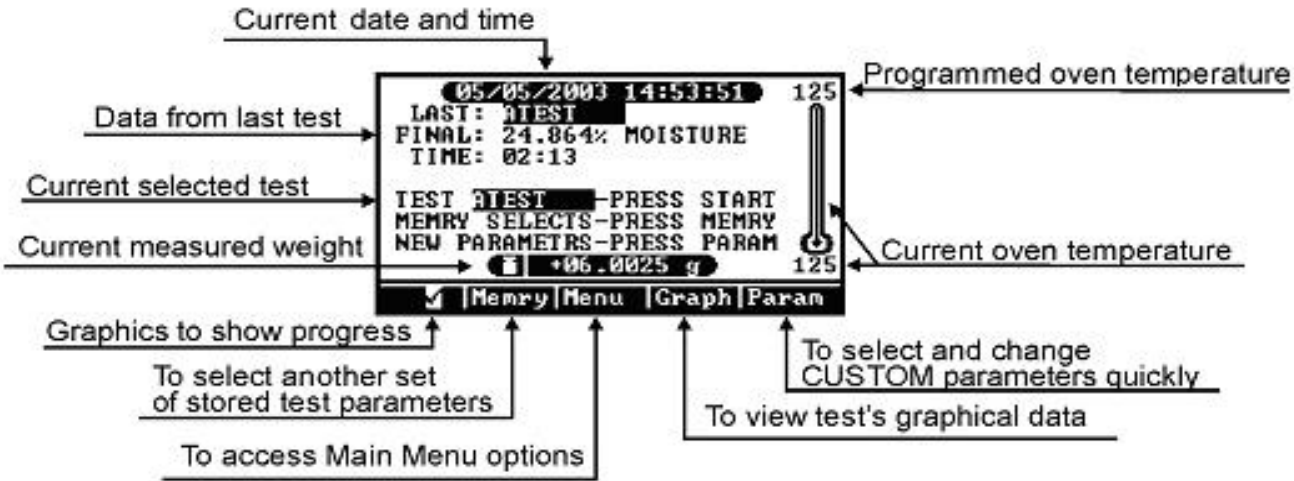

Main Test Screen

- Moisture tests are started by pressing the [START] key.
 - If the Login feature is active, a user must be logged in before testing can commence. See **Login** on page 17 for more information.
 - If all system parameters have been selected for the selected test, no other keystrokes are required to complete most tests.
 - Follow the steps as they appear on the screen, and wait for the audible signal at the end of the test.



- The four arrow keys, [◀], [▶], [▲], [▼], are used to navigate through the menu system, and to respond to prompts on the screen. The function of the key appears above the key. As an example, the name [Param], above the [▼] key, changes to [Quit] during tests. This indicates that the test will be terminated and computations canceled when the key is pressed.



- When using the menu system to change a numeric value, such as a name or temperature:
 - Use [◀] and [▶] to select the character position to be changed.
 - Use [▲] and [▼] to increase or decrease the character in the selected position.

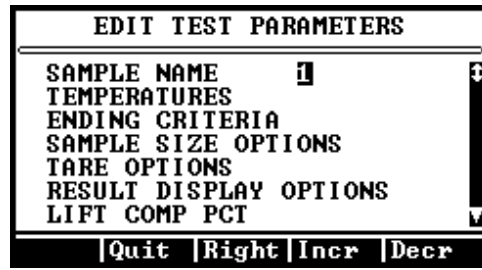

- The alphanumeric digit/place can contain one of 12 symbols in addition to the alphabet and the numbers 0 to 9. Pressing [Incr] starts at "A" and continues through the alphabet, the symbols, then the numbers. Pressing [Decr] first starts at the numbers, then symbols and finally, the alphabet.
- When the changes are completed, move the cursor off the end of the entry, either to the left or right, to "Quit" the edit mode.
- Use [▲] to accept or [▼] to cancel the changes made.

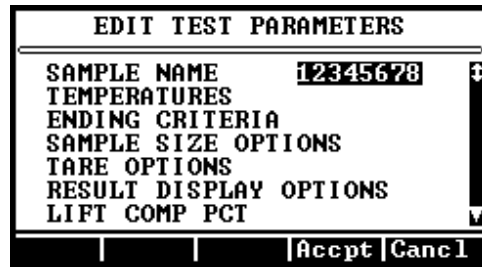
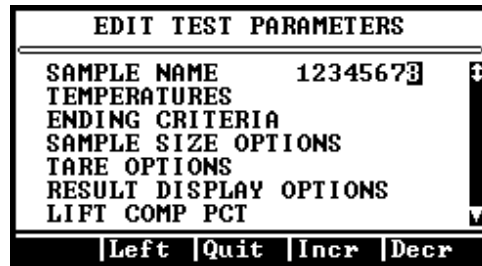

NOTE: Prompts to remind the user of key functions are always displayed above the keys and change as necessary throughout the menu system.

5.5. Login

For tracking and control, the Login feature can be activated, and a user must be logged in to the MAX[®] 2000XL before testing can commence.

If Login is activated, pressing [START] to begin a test will bring up the login screen. The login screen will display the ID of the user currently logged in to the instrument. If this user is correct, press [START] again to proceed to testing. If the ID field is blank, no user is logged in, and a previously setup user can enter their ID and password to login to the instrument and begin testing. To change users, press LGOUT to logout and then input the desired user ID and password. See **Login Setup** on page 48 for instructions on setting up users. If necessary, see section **5.4 Controls** starting on page 15 for a review of text entry keystrokes and procedures.



On the Login screen, press [Edit] to access the ID field. Use [Incr] and [Decr] to change the highlighted field to the desired character, and [▶] and [◀] to move between characters. Once the ID has been entered, press [▶] repeatedly until the [Accept] button appears, then press [Accept] to save the ID. Next, press [Ln Dn] to highlight PSWRD, and then press [Edit] to access the PSWRD field. Again, use [Incr] and [Decr] to change the highlighted field to the desired character, and [▶] and [◀] to move between characters. Once the PSWRD has been entered, press [▶] repeatedly until the [Accept] button appears, then press [Accept] to save the password. If the ID and PSWRD are valid, the MAX[®] 2000XL will respond with LOGGED IN, PRESS START TO BEGIN TEST. If the ID and PSWRD are not valid, KEY ENTRY INCORRECT PLEASE RE-ENTER will be displayed instead. The ID must be entered before the password.

After the ID and password have been entered successfully, press [START] to begin immediate testing or [Esc] to exit to the Main Test Screen. The user ID of the user who ran a test can be printed along with the other test data, as described in **Report Control Options** on page 46.

To logout, cycle the instrument power off and then back on or use the LGOUT button on the bottom left of the login screen. The LGOUT button will erase the User ID currently listed on the login screen. Press [Esc] to exit the login screen after logging out.

In addition to the Login feature, the programming features can be placed under Access Code control to prevent unwanted changes to operating parameters. See **Access Key Setup** on page 48 for more information.

5.6. Setting Calibration Prompts

- There are prompts available to remind you when scheduled calibrations are due. The default factory settings are:
 - Prompt Enable - ON,
 - Start Date - (Factory Calibration Date,)
 - Prompt Time - 07:00, and Interval - 04 Weeks.

- To select the Balance Calibration Prompt:

- Select in order, Menu, Calibration Menu, Balance Calibration, and Setup Balance Cal Prompt.
- Toggle the Prompt Enable to OFF or ON.
- Edit the Start Date to the desired date to begin prompt intervals.
- Edit the Prompt Time to the time of day the prompt is to be activated, usually the start of shift/work time.
- Edit the Interval to indicate the number of weeks between prompt displays.

SETUP BALANCE CAL PROMPT
PROMPT ENABLE: ON
START DATE: 10/24/2002
PROMPT TIME: 07:00
INTERVAL: 04 Weeks
Left Right Incr Decr

- To setup the Temperature Calibration Prompt:

- Select in order, Menu, Calibration Menu, Temperature Calibration, and Setup Heat Cal Prompt.
- Toggle the Prompt Enable to OFF or ON.
- Edit the Start Date to the desired date to begin prompt intervals.
- Edit the Prompt Time to the time of day the prompt is to be activated, usually the start of shift/work time.
- Edit the interval to indicate the number of weeks between prompt displays.

SETUP HEAT CAL PROMPT
PROMPT ENABLE: ON
START DATE: 10/25/2002
PROMPT TIME: 08:00
INTERVAL: 04 Weeks
Quit Right Incr Decr

- It is not necessary for a user to be logged in to set the calibration prompt options.
- A factory-set prompt will notify the user when 11 months have elapsed since the last annual factory calibration. The 11-month point will give the user time to schedule factory calibration. Call AZI Customer Service at 1-800-528-7411 or 1-602-470-1414 for details and directions on factory calibration. The prompt may be cleared but it will reappear periodically until it is reset at the next factory calibration.

5.7. Calibrate Balance - 20 gram weight required

- The balance should be calibrated:
 - Immediately after initial setup,
 - Whenever the instrument is moved,
 - Whenever a problem is suspected, or
 - As your Quality Policy dictates.
- It is not necessary for a user to be logged in to perform the balance calibration, however, access to the calibration functions can be controlled using Access Codes. See **Access Key Setup** on p. 48
- The screen will prompt you to have a clean, dry sample pan, and a 20-gram calibration mass available before beginning the calibration process.

NOTE: Best results are obtained if the MAX[®] 2000XL has been turned on for 20 to 30 minutes, depending on ambient temperature, and the chamber temperature stabilized at 80 °C for five minutes prior to calibration. A vibration-free table will speed the calibration process since the balance will stabilize more quickly if it is not subject to vibration.

- Preheat the chamber to 80 °C:
 - Ensure the lid is closed and press the [**Memry**] key to display the list of memory starts.
 - Highlight memory start 001 ID: TARTRATE and press the [**START**] key.
 - If the Login screen appears, press [**Esc**] twice to return to the Main Test Screen. If the Login screen does not appear, press [**Quit**] to return to the Main Test Screen. The unit will heat the chamber to the 80 °C programmed idle temperature. (It is not necessary to Login to calibrate the balance.)
 - **Wait five minutes.**
 - Proceed with the balance calibration procedure.
- Balance calibration procedure:
 - Press [**Menu**].
 - Select the CALIBRATION MENU.
 - Highlight BALANCE CALIBRATION and press [**Selct**].
 - Ensure CALIBRATE BALANCE is highlighted and press [**Selct**].
 - Press [**GO**] to begin the calibration procedure. Follow the prompts to complete the calibration.
 - The first prompt is “OPEN THE LID.”
 - After placing a clean pan on the balance and closing the door, the screen will indicate “TARING PAN – PLEASE WAIT.”
 - As soon as the tare is finished, the next “OPEN THE LID” prompt will appear.
 - As the lid is opened, the screen prompts:

PLACE 20g CAL MASS
ON CENTER OF PAN
HANDLE CALIBRATION MASS
CAREFULLY.

CLOSE LID TO CONTINUE



Avoid excess pressure on the scale. Use the tweezers to gently place the weight on the pan.



- With the 20-gram weight in place, gently close the lid.
- As the MAX[®] 2000XL calibrates itself, the screen displays the “CALIBRATING BALANCE” message.
- For best results, the unit should not be moved, jarred, or otherwise disturbed in any way during this calibration time.
- When the calibration is complete, the screen displays the results.
- If the result is $+20.0000 \pm 0.0015$ g, the calibration was successful and the MAX[®] 2000XL is ready for use.

CAL RESULT: +20.0000 g
STATUS: PASSED
- If the weight result is out of this range, the calibration was unsuccessful. Rerun the calibration.

CAREFULLY REMOVE CAL MASS
HIT ESC TO EXIT
- If the calibration fails again, contact AZI Customer Service at 1-800-528-7411 or 1-602-470-1414.
- Press [Esc] four (4) times to return to the Main Test Menu.

5.8. Verify Balance

The MAX[®] 2000XL v4.36 has a Balance Verification feature that verifies the linearity of the balance across the operating spectrum of the balance. Utilization of this feature is optional, as the instrument will perform to its specifications whether or not the verification is run. However, if your Quality Policy or Standard Operating Procedures mandate verification of the balance in the instrument, this feature is available to satisfy those requirements.

- The balance should be verified:
 - Immediately after initial setup (if desired),
 - Whenever a problem is suspected, or
 - As your Quality Policy dictates.
- The Balance Verification should only be performed if the instrument has already successfully passed the Balance Calibration.
- It is not necessary for a user to be logged in to perform the balance verification, however, access to the verification functions can be controlled using Access Codes. See **Access Key Setup** on page 48.
- The instrument temperature must be 40 °C or less to verify the balance. If the instrument has been running at high temperatures, a 2-hour cooldown is recommended before performing balance verification.

There are three Balance Verification routines, each requiring an appropriate NIST traceable ASTM Class 3 or better weight set:

- Full Range
 - Verifies the full range of the balance across eight (8) points from 0 to 40 grams.
 - Requires a set of eight (8) NIST traceable ASTM class 3 or better 5-gram weights.
- Mid Range
 - Verifies the mid range of the balance across five (5) points from 0 to 10 grams.
 - Requires a set of five (5) NIST traceable ASTM class 3 or better 2-gram weights.
- Low Range
 - Verifies the low range of the balance across five (5) points from 0 to 2.5 grams.
 - Requires a set of five (5) NIST traceable ASTM class 3 or better 0.5-gram weights.

The Balance Verification functions are available from the **Balance Calibration Menu**, which is discussed in more detail on page 41.

To access the functions:

- From the Main Test Screen, press the **[Menu]** key.
- Highlight Calibration Menu and press the **[Selct]** key.
- Highlight Balance Calibration and press the **[Selct]** key.
- Highlight the desired Verification routine and press the **[Selct]** key to begin.



To perform the Verifications, follow the on-screen prompts to add and remove weights until the instrument indicates the verification is finished. The results of the balance verification will be displayed and will also print as part of the Balance Calibration Report.

There is an Enter Device Data selection available from the Balance Calibration Menu. Serial numbers and certification dates for the weight sets used in the verification can be input here and stored in the instrument.

5.9. Weight Test - three and five gram weights required

If the Login feature is active, a user must be logged in before testing can commence. See **Login** on page 17 for more information.

To ensure proper calibration and become familiar with the instrument, run a weight test. This test simulates moisture content by the removal of one of two known weights.

- Ensure a clean, dry, empty sample pan is placed on the pan support.
- From the Main Test Screen, press the **[Memry]** key.
- If the highlight bar is not already there, highlight “000 ID: WEIGHT” and press **[START]**.
 - If the Login feature is active, the login screen will be displayed before the test begins.
- When the “OPEN THE LID” prompt appears on the screen, open the lid and carefully place both a 5-gram and a 3-gram weight near the center of the sample pan.
- Close the lid.
- After the testing screen is displayed, gently open the lid and carefully remove the 3-gram weight.
- Wait for the end of the test.
- If this is the first test of the day, discard the results of this test for stability reasons.
- Record the final result. The value should fall between 37.480% and 37.520%.

5.10. Connecting Nitrogen Purge Kit - AZI P/N 990-0046



CAUTION:
Use of nitrogen or other inert carrier gas does not create an explosion-proof system.



Some applications may require the use of a nitrogen purge to remove volatiles from the chamber.

- In addition to the Nitrogen Purge Kit, the following materials will be required for the nitrogen purge setup:
 - Nitrogen source/cylinder or other supplied inert gas source
 - Two-stage regulator capable of regulating pressure to 5 psi
 - For cylinder applications: Multi-stage Gas Regulator for Compressed Air Cylinder, VWR #55850-150, # 55850-155 or equivalent, or Matheson Gas Products Brass Dual Stage Regulator, model 8L or equivalent
 - For supplied gas sources: Matheson Gas Products Model 3471 Single Stage Line Regulator or equivalent.
 - Tubing with a 1/8" (.31 cm) inside diameter (I.D.) and, 1/4" (.625 cm) outside diameter (O.D.) - Vinyl tubing (VWR #63013-029), or Nalgene clear plastic tubing (Nalgene #8000-0020, VWR #63015-368)
 - Connector, 1/8" I.D., 1/4" O.D.

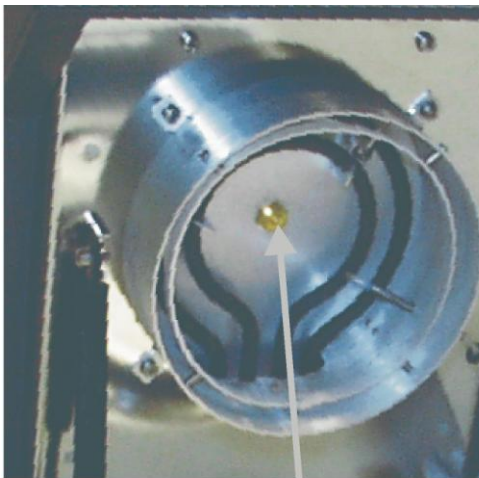

Remove plug and install air diffuser inside.

Remove plugs and install .007 and .012 orifice fittings outside.



- Open the lid.
- Remove the plug that is centered in the heater ring.



NOTE: Use caution when installing the air diffuser. Tighten it finger tight only to prevent breakage.



- Install the air diffuser and seal, supplied with the Nitrogen Purge Kit, into the opening created by removing the plug.
- Close the heater lid.
- From the back of the unit, remove the plug located in the upper left corner (as viewed from the rear) of the heater lid.
- Install the .007 orifice fitting (it has the green insert), supplied with the Nitrogen Purge Kit, into the opening created when the plug was removed.
- From the back of the unit, remove the plug from the lower portion of the unit.
- Install the .012 orifice fitting (it has the black insert), supplied with the Nitrogen Purge Kit, into the opening created when the plug was removed.
- Connect the regulator to the gas source/cylinder per the regulator manufacturer's instructions.
- Use tubing to connect the outlet of the regulator to the “Y” connector supplied with the Nitrogen Purge Kit.
- Connect tubing from the “Y” connector’s two outlets to the fittings on the rear of the unit.
- Check that all fittings are gas tight and secure. Pressure should be deferred until the start of a test to conserve gas use. Flow rates will be sufficient with the pressure set to between 4 and 5 psi.

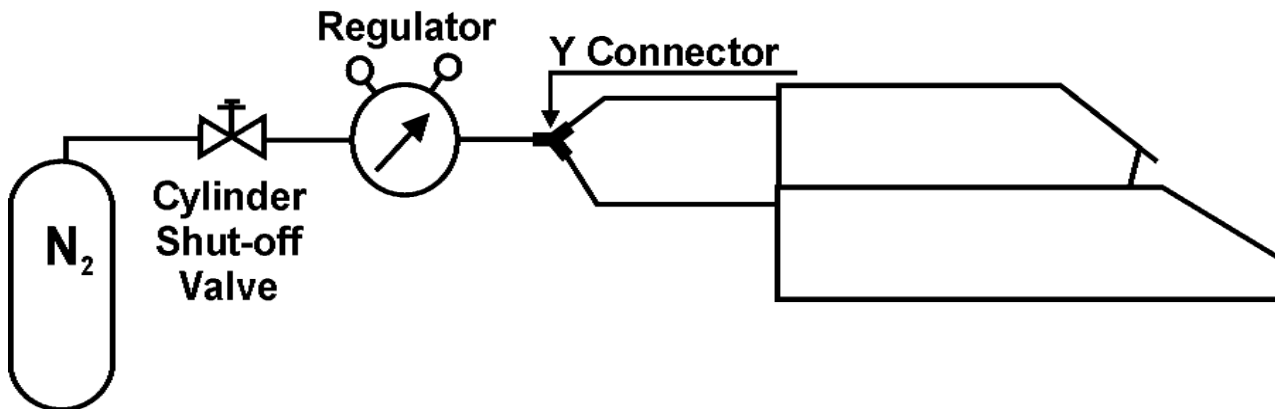

5.11. Connecting a Printer



An optional graphic-capable printer is available from AZI as AZI P/N: Y990-0098 (printer pictured is example only). It connects to the printer port at the rear of the instrument. The content and time of printing for each message can be custom configured from the menu system. These same messages can be directed to a computer through the RS-232 serial port at the back of the instrument.

- Turn off the MAX[®] 2000XL if it is turned on.
- Unpack the printer, cable and paper. Install the paper according to the instructions in the printer manual. Plug the large end cable connector into its mating socket on the printer, and the small end into its mating socket on the back of the MAX[®] 2000XL. Plug the power cord into the printer, and into a GROUNDED power receptacle.
- Turn the printer power on and wait for it to power up. (On some older printers it is also necessary to place the printer “On Line.”). When the printer is idle, then turn the MAX[®] 2000XL on.

NOTE: If the printer is supplied with the MAX[®] 2000XL from AZI, the unit is already programmed. If the printer is obtained from another source, refer to its manual for programming information.

- To set up the MAX[®] 2000XL, begin at the OPENING MENU and press [**Menu**]. Press the [**Down**] key until SETUP MENU is highlighted and press [**Select**].
- Highlight PRINTER TYPE and press [**Edit**], to allow the selection to be changed. Press [**Incr**] or [**Decr**] to change the selection between available types. When the correct type is displayed, press the [**Accept**] key to lock the selection into the MAX[®] 2000XL parameters.
- Move the select bar to OUTPUT PORT and press [**Edit**], to allow the selection to be changed. Press [**Incr**] or [**Decr**] to change the selection between **LPT** for printer only, **RS-232** for Computer only, and **Both** for the printer and computer at the same time. When the correct port selection is displayed, press the [**Accept**] key to lock the selection into the MAX[®] 2000XL parameters.
- Move the select bar to AUTO FORM FEED and press the [**Toggle**] key to select between OFF and ON. When the correct selection is displayed, press the [**Esc**] key two times to return to the MAIN TEST SCREEN. NOTE: Selection will depend on the printer used. Try Auto Form Feed ON for most printers. If the printer seems to waste paper, switch it to OFF.
- With the MAIN TEST SCREEN displayed, press the [**Menu**] key to display the MAIN MENU. Go down to the SETUP menu and press [**Select**]. Highlight REPORT SETUP and press [**Select**] again. With REPORT CONTROL OPTIONS highlighted, press [**Select**] again.
- With REPORT ENABLED highlighted, press the [**Toggle**] key, to select between YES and NO. Select YES to send the test results to the printer and NO to stop results from being sent to the printer.
- Highlight REPORT START and press [**Edit**]. Press [**Incr**] or [**Decr**] as necessary to select either START TEST, 1st PRED (first prediction), or TEST END.

- Highlight REPORT INTERVAL and press **[Edit]**. Press **[Incr]** or **[Decr]** to select an interval between the minimum of 02 seconds and the maximum of 99 seconds. Press the “Accpt” key to lock the selection into the MAX[®] 2000XL parameters.
- Highlight INCLUDE GRAPH and toggle the NO to a YES if you have the LPT output port only selected and want to print the graphic plot of weight and moisture loss for a test.
- Press the **[Esc]** key to return to the REPORT SETUP MENU.
- Move the select bar to REPORT ITEMS TO PRINT and press the **[Select]** key. Move up and/or down through the list and select the items to be printed.
- Press the **[Esc]** key until the MAIN TEST SCREEN is displayed.
- To verify that the MAX[®] 2000XL and the printer are connected and working together, perform a weight test and monitor the printing operation.

5.12. Connecting a Computer

If you wish to monitor the test with a computer, connect a null modem cable (AZI P/N: 6000-1044) to the smaller of the two "D" connectors at the rear of the instrument. Use any serial port communications program (not provided) on your computer to read the messages emitted at the MAX[®] 2000XL serial port. The content of each message can be selected from the REPORT ITEMS TO PRINT menu which is described on page 46.



- The MAX[®] 2000XL comes equipped with RS-232 communications available at a 9-pin standard serial communications socket at the rear of the instrument. The standard communications parameters used are 9600, N, 8, 1 (9600 baud, no parity, eight data bits, one stop bit). Refer to your computer communications program manual for instructions on configuring the PC to read this data format.
- The MAX[®] 2000XL does not test to see if the connected device is actually ready (or even present), nor does it respond to a request by the connected device for status information.
- Since the MAX[®] 2000XL can send data to both the RS-232 port and the parallel printer port at the same time, the same procedure to direct the output to the printer routes the output to the computer as well. The computer will not understand the graph that is printed by the printer. Therefore, the menu selection found at Setup-Menu, Report Setup, Report Control Options, Include Graph, must be set to "NO," if the MAX[®] 2000XL is connected to a computer.

5.13. MAX[®] 2000 Communication Software

- Arizona Instrument offers a communication software package which enables the user to:
 - Transfer memory start parameters to and from one or more instruments and store them by instrument serial number.
 - Download memory start parameters to other instruments.
 - Store test data from the instrument's stored data function in a computer.
 - Poll and/or interface with multiple instruments using Instrument Network Modules or a Code Operated Switch.
- If you have any questions about this software package, call your technical sales representative at 1-800-528-7411 or 1-602-470-1414.

5.14. Test Procedure

This section briefly describes the steps in running a test on a product sample. For more information on moisture analysis, see section **11 PERFORMANCE ENHANCEMENT** on page **53**. If the Login feature is active, a user must be logged in before testing can commence. See **Login** on page **17** for more information.



CAUTION:
Mechanical stops offer some limited protection to the balance mechanism from overload damage caused by vertical forces. To prevent damage to the balance, use care not to push, pull, twist, turn or bump the sample pan support excessively.



- Obtain a sample of test material and transport it in an airtight container to prevent moisture gain or loss through contact with the atmosphere.
- If the instrument has already been configured for your test material, simply place a clean sample pan on the pan support, press **[START]** and follow the instructions displayed on the screen. If not set up, the material parameters must be entered before accurate testing may begin. See the **PERFORMANCE ENHANCEMENT** section that starts on page **53** and the **Memory Start Menu** section that starts on page **31** for how to store the test setup for future use. Call your technical sales representative at 1-800-528-7411 or 1-602-470-1414 for assistance in installing your parameters.
 - Install a clean dry sample pan and press **[START]**.
 - If the Login feature is active, the login screen will be displayed before testing can begin.
 - When **LOAD SAMPLE** appears on the display, add sample.

NOTE: If the instrument displays **LOAD SAMPLE**, but the balance stored a tare weight greater than +/- .0003 grams, press “**START**” key again. If it will not zero, quit the test and start again.

- Load the sample quickly, taking care to distribute it evenly across the entire surface of the pan to get the fastest and most accurate results.
- After **[START]** has been pressed, a weight error message may appear on this screen. For example, if no pan or pan support is on the balance, **UNDERLOAD** will be displayed. If the weight on the sample pan exceeds 40 grams, **OVERLOAD** will be displayed. If an empty sample pan is in place, and either of these displays appear, turn the unit off and clean out any debris found beneath the pan support. Reassemble the parts and be sure that no mechanical interference is present. It may be necessary to calibrate the balance (see page 19). If these measures fail to restore normal function, call AZI customer service at 1-800-528-7411 or 1-602-470-1414 for assistance.
- The internal balance weight reading is always visible at the bottom of the screen when in the operating mode.

- While loading the sample, the weight is displayed in grams at the bottom of the screen and on a horizontal bar at the top. The target weight is entered under SAMPLE SIZE OPTIONS. Add the sample so that the solid bar is at or near the target weight and the instrument produces audible beeps.
- Close the lid to begin the test.
- While a test is in progress, the horizontal bar is not displayed. Only the weight in grams is displayed at the bottom center of the screen (shown as +08.0000 grams in the example picture at right).

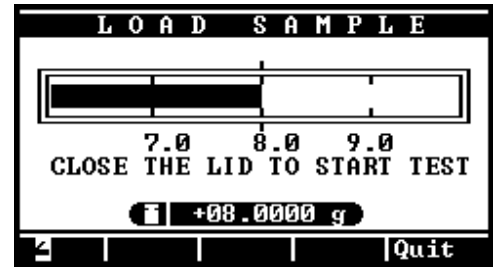

- To load difficult samples more easily, remove the sample pan from the instrument after the correct amount of sample has been placed on the pan and place the filled pan on a level work surface. Spread the sample with a small flat brush or spatula, depending on the consistency of the sample.
 - Replace the loaded sample pan on the pan support and close the cover.
- To determine analyzer performance on a new product sample, repeat each test five (5) or more times to obtain reliable information about the standard deviation of a typical result. Each test result is automatically stored, recording the date, time, and test setup name. The instrument can calculate the mean, standard deviation, and coefficient of variation of a set of tests through the Stored Data Menu.

5.15. Test Data Output

- Test results are displayed on the Main Test Screen, Graph Screen, or Data Screen and can be sent to a printer and/or to a computer (the computer cannot receive the graph).
 - The LCD screen can display a graphic depiction of the moisture curve (weight loss percentage) and predicted final value during the test when the [GRAPH] key is pressed. This information is helpful in determining the proper test parameters for a new sample material.
 - The test data and a graph can be sent to a printer but only the test data can be sent to a computer for storage. For printer output, connect a standard PC parallel printer to the MAX[®] 2000XL printer port. For communications with a computer, connect a null modem cable between the MAX[®] 2000XL RS-232 port and a computer running communications software. Call AZI Customer Service or your technical sales representative at 1-800-528-7411 or 1-602-470-1414 for more information on this software.

6. MENU SYSTEM: INSTRUMENT CONFIGURATION AND OPERATION

The MAX[®] 2000XL is controlled by various parameters and commands entered into the instrument by way of keypad operations as prompted by the display. The entire set of commands and displays is accessible through a menu tree with each choice selected at the time of need by specific keystrokes.

The Main Test Screen, which appears a few seconds after the instrument is powered up, displays the current date and time, the last test parameter set name, the last test result, the last elapsed test time, and the idle temperature setpoint, as shown below. The Main Test Screen is also the top of the menu tree and displays the name of the four functions selectable by the four arrow keys.

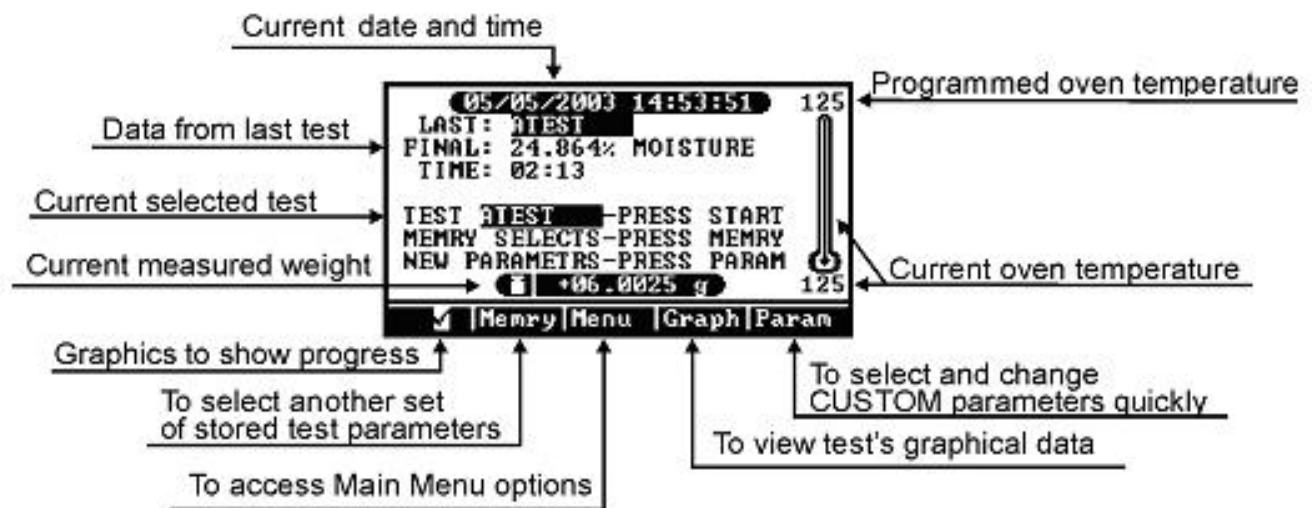

- The left most selection is **[Memry]** and will switch the display to a list of stored test parameters (Memory Starts).
- The next selection is **[Menu]** and will switch the display to the Main Menu from which most test parameters and functions are accessed.
- The next selection is **[Graph]** and will change the display to a graph of the moisture content of the sample as a function of elapsed test time.
- The right most selection is **[Param]** and allows the parameters of the Memory Start Test at ID:246 CUSTOM, to be changed quickly between tests.

If access code control is active, edits to some components of the menu system will bring up a message asking for the access code. For more information on the access code, see **Access Key Setup** on page 48.

If the Login feature is active, a user must be logged in before testing can commence, and when the **[START]** button is pressed to begin a test, the Login screen will appear. If the correct User ID is displayed, press **[START]** to begin testing. If the User ID is blank, a user must login before testing can commence. To switch users, press LGOUT to logout and then enter the desired user ID and password. For more information, see **Login** on page 17.

6.1. MAIN MENU

At the Main Test Screen, pressing the [Menu] button will display the four top-level selections of the menu system.

- **MEMORY START MENU** is used to make changes to the Memory Start stored parameter sets.
- **STORED DATA MENU** is used to view, analyze, print, and/or delete data from past moisture determinations.
- **CALIBRATION MENU** is used to perform balance and heater calibrations.
- **SETUP MENU** is used to enter and/or edit instrument default parameters for the printer, reports, internal clock, data format, user ID's and passwords, and the access key, or codes, used to control parameter change access.
- The four arrow keys, [◀], [▶], [▲], and [▼], are used to navigate through the menu system, and to respond to prompts on the screen. To select a menu item, move the selector bar up or down the displayed list to the desired function using the [▲], or [▼], arrow keys. If the list is longer than can be displayed on a single screen, a scroll bar will be displayed at the far right of the screen. Arrows on the scroll bar will indicate available screens, below and/or above the current screen. Press [Select] to choose the option or move to the next menu level, or press [Esc] to return to the previous menu level.



6.2. Memory Start Menu

The Memory Start Menu allows access to the stored test parameter sets. This is where the contents of the stored parameters may be printed out or changed.

- Selecting any of the four options in the Memory Start Menu brings up the list of stored test parameter sets. They are sequentially numbered from 000 to 246.
- The first and second, 000 ID: WEIGHT and 001 ID: TARTRATE, are factory-set in non-volatile memory and cannot be changed.
- The last, 246 ID: CUSTOM, can be changed through this menu or using the **[Param]** key at the Main Test Screen.
- The left-most key is now labeled **[Line]**. The **[Ln Up]** key will move the highlight upwards through the selections one-at-a-time. The **[Ln Dn]** key will descend through the selections one-at-a-time.
- Pressing the **[Line]** key will change this key to **[Page]**. The **[Ln Up]** and **[Ln Dn]** keys will change to **[Pg Up]** and **[Pg Dn]**. They will now scroll through the selections seven lines, or one display page, at a time.
- Individual selections cannot be made in Page Mode. Therefore, to scroll one line at a time, turn Page Mode off by pressing the **[Page]**.
- With Page Mode turned off again, the **[Ln Up]** and **[Ln Dn]** prompts reappear over the respective keys and individual selections may be made.

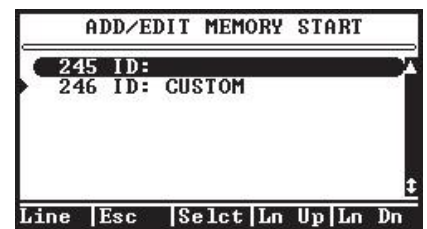
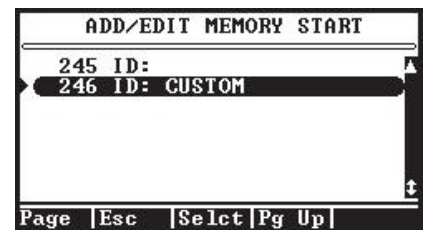
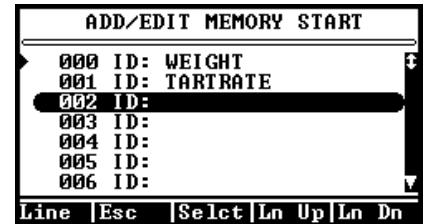

➤ Add/Edit Memory Start

Used to create or alter a stored set of test parameters. The seven options/parameters available at each memory start selection are discussed in the following paragraphs. Once a selection is made, follow the displayed screen prompts to complete the editing process. Refer to page 5.4 if necessary.

⇒ Sample Name

An eight (8) place alphanumeric identification for the test. Each ID location will be blank when first opened. Edit the value to any desired name or number to identify the product under test.

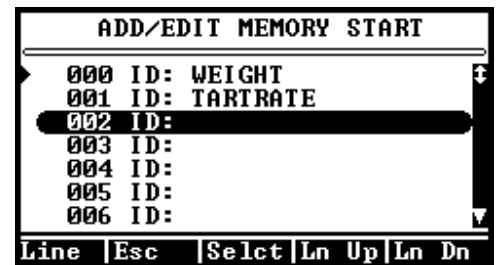

⇒ Temperatures

The three possible temperature parameters used during a test. Temperatures less than 25 °C, if entered, are accepted and displayed, but stored and interpreted as 25 °C.

TEMPERATURES	
TEST TEMPERATURE	160°C
TEST HISTART TEMP	025°C
IDLE TEMPERATURE	025°C
START TEMP CONTROL:	OFF

|Esc |Edit | |Ln Dn

Test Temperature

The current temperature setpoint is displayed after TEST TEMPERATURE. Press **[Edit]** and the cursor will be positioned at the first (most significant) digit. Use the up or down arrows to increase or decrease the digit value. Press the right arrow key to move to the remaining digits to be edited and change each appropriately. When finished, move the cursor to the end digit and press the key labeled **[Quit]**. To register the change, press the key labeled **[Acpt]**. To cancel the change, press the key labeled **[Cancel]**. The display remains at the TEMPERATURES screen.

Test Histart Temperature

Sets two temperatures for a test, one higher at the beginning and one lower partway through the test.

- The instrument begins a test at the HISTART TEMPERATURE, and continues at that temperature until the rate of moisture loss falls to half of its peak value. The heater then changes to the test temperature setpoint for the remainder of the test.
- The MAX[®] 2000XL prediction algorithm is so fast, this process is usually not necessary.
- To deactivate the HISTART feature, set the TEST HISTART TEMP to 25 °C.

Idle Temperature

The temperature maintained by the instrument between tests. This speeds testing by decreasing the time required to heat the sample chamber at the beginning of the test. It can save 10 to 90 seconds of test time if properly used. A common idle temperature value is 50 °C but any value above room temperature (but below 150 °C) can be used. Experiment to see what value is best for your application. Too high a value will cause low results because the sample is evaporating while the basis weight is being measured at the beginning of the test.

Start Temp Control

Prevents a test from starting if the chamber temperature is more than two degrees hotter or colder than the IDLE TEMPERATURE. This feature can improve the standard deviation of results of some temperature-sensitive materials. When this feature is enabled and an over or under chamber temperature is detected, an alarm will sound and the test will quit.

If **[START]** is pressed when the chamber is too hot, the alarm will sound and the following message will be displayed: “CHAMBER TEMPERATURE IS HIGH. Open the lid and wait for the alarm.” Open the lid. An alarm will sound as the temperature reduces an appropriate amount below the idle temperature. Close the lid and press **[START]**. The alarm will sound and the “CHAMBER TEMPERATURE IS TOO LOW” warning will sound. Keep the lid closed and the alarm will sound again when the temperature has risen to within two degrees (2 °C) of the set idle temperature. Press **[START]** and this time the test will proceed normally.

If [START] is pressed when the chamber is too cold, the alarm will sound and this message appears: “CHAMBER TEMPERATURE IS LOW. Leave lid closed and wait for the alarm then re-start test.” The alarm will sound again when the temperature has risen to within two degrees (2 °C) of the set idle temperature. Press [START] to begin the test.

When the TEMP CONTROL is disabled, a test can be started at the oven temperature at that time.

➤ **Ending Criteria**

Used by the instrument to automatically end a test. This feature makes it unnecessary for the operator to monitor the analyzer while it is performing a test. Selecting this option will display the three ending criteria options.

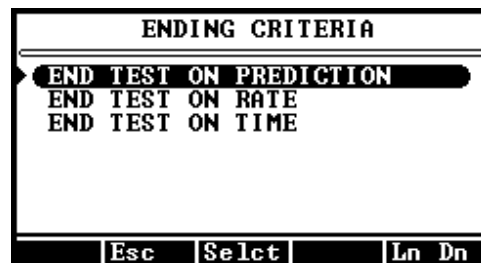

⇒ **End Test on Prediction**

The MAX[®] 2000XL uses an advanced version of the AZI moisture prediction method to automatically end each test early to speed test results. The prediction method relies on the fact that most samples exhibit a weight loss trend such that the rate of volatilization is proportional to the amount of volatile material remaining in the sample. The resulting weight trend approximates an exponential function, and the prediction algorithm models this exponential function continuously, updating the prediction. When the prediction is sufficiently stable and reliable, the test ends and the predicted endpoint is displayed, stored in the instrument, and printed if an accessory printer is enabled and attached. Proper selection of the ending criteria can greatly improve the test times and repeatability.

Auto Criteria Selection

The MAX[®] 2000XL monitors the progress of moisture determination and automatically selects the ending criteria most appropriate to the test under way.

Manual Criteria Selection

In a few instances, best performance will be achieved by adjusting the ending criteria. The first manual-ending criterion is called the Reliability Test, and is activated when the predicted final value and the actual weight loss are sufficiently close together. The number displayed is a percentage, equal to the actual weight loss divided by the predicted end point, times 100%. For example, if 90% is entered, the test will end when the actual weight loss is 90% or more of the predicted end point.

The second manual-ending criterion is called the Stability Test. It is a measure of the variance or instability of the prediction.

As the equation to the right indicates, a perfectly stable (unchanging) prediction would have an instability of zero. It is zero if the current prediction and the previous two predictions are the same value.

$$1 - \left(\frac{\text{Current Prediction}}{\text{Historical Prediction}} \right)$$

A prediction that varied over a 2 to 1 range would have an instability of 1.000. It is not practical to have stability numbers greater than 0.010 or less than 0.003.

In general, standard deviation will improve as stability of the prediction increases and decline as stability decreases. Selection of the proper stability value is a matter of experiment and judgment but can be made easier by printing out the results of multiple tests for comparison.

⇒ **End Test on Rate**

This feature ends the test when the weight loss rate falls below a selected value. This is a “percent per minute” value. For example, entering 0.100 means that the test will end when the rate of change of the actual weight loss per minute is less than 0.100 % of the original sample weight.

The instrument's program assumes that the sample contains volatile material that will completely evaporate after some time. It further assumes that, at first, the rate will increase to a maximum point, and then gradually decrease to zero. Selecting some threshold rate values will cause the test to end before the sample is completely dry. Rate is useful to profile a sample's weight loss. Some applications are faster in the rate ending criteria. Others are faster in the prediction ending criteria.

Some samples contain more than one volatile material, for example nylon resins with large amounts of unpolymerized material (Caprolactam). In these cases, the rate will fall to some fixed value when all the moisture is evaporated but while the monomer is still evaporating. The graphical display available from the Main Test Screen is of great help in visualizing these cases. The rate ending criteria, if set above the rate of monomer volatilization, may give the best results.

⇒ **End Test on Time**

This feature places a time limit on a test. The test will end when a selected amount of time has passed.

Fixed time tests are seldom superior to the prediction algorithm, but can be useful when conducting application characterization tests, or when investigating long term stability of the instrument.

➤ **Sample Size Options**

This feature enters a target sample size and the minimum and maximum sample range. Sample size ranges can be programmed from 0.2 gram to 39.8 grams.

⇒ **Sample Size**

The sample size should be consistent for all tests on a particular product in order to get the best standard deviation possible.

SAMPLE SIZE OPTIONS	
SAMPLE SIZE	8.0g
SAMPLE WINDOW	± 1.0g
INSIDE LIMITS	TWO BEEPS
OUTSIDE LIMITS	NO BEEPS
Esc	Edit Ln Dn

High volatile materials, such as coatings, typically require smaller sample sizes (one to three grams). Low volatile materials, such as low moisture resins, typically require sample sizes from 20 to 30 grams. Contact your technical sales representative at 1-800-528-7411 or 602 470-1414 for appropriate sample sizes.

⇒ **Sample Window**

The numbers entered set the center and tolerance values of the horizontal weight scale that is displayed when sample is being added. See Section 5.14 for a picture of the weight scale display.

⇒ **Inside Limits and Outside Limits**

Selections of no sound, one beep or two beeps may be programmed to signal when the weight of sample added is inside or outside the user-defined sample quantity tolerances.

➤ **Tare Options**

There are two tare options, Pan Tare and Sample Tare, that define how stable the balance must be before a test will start. The third tare option is labeled Special Options and is used to tare a syringe, foil tray or other lightweight device used to carry or hold the sample on the pan.



⇒ **Pan Tare Options**

This setting ensures that the drift in the measured weight of the empty pan is less than a given number. Pan Tare refers to the first step in a moisture test, the taring of an empty sample pan. Temperature fluctuations occur across the balance and are dependent on a number of different criteria such as previous test setpoint temperature, the amount of cool-down time between tests, and the current idle temperature. This temperature fluctuation causes the balance to drift during and after the sample pan tare and is reflected as error in the final moisture value. Since the conditions that cause the temperature fluctuation across the balance are not always constant, this error often appears as a higher standard deviation for a series of tests on a particular sample.



The Pan Tare Option offers the user four mutually exclusive selections to adjust the relationship between tare-time and tare-error to improve overall operation for a given product or purpose. The following table summarizes the menu choices and the parameters associated with each choice.

MENU CHOICE	INITIAL TARE TIME	POTENTIAL DRIFT ERROR	POTENTIAL TARE TIME
FAST	6 seconds	up to 20 mg	6 seconds
STANDARD	6 seconds	1.0 to 2.0 mg	UP to 60 seconds
LOW MOISTURE	18 seconds	less than 1.0 mg	UP to 2 minutes
ULTRA-LOW MOISTURE	30 seconds	less than 0.3 mg	UP to 3 minutes

The FAST tare option, as the name implies, is the fastest. If this option is selected, the MAX[®] 2000XL zeros the balance, waits six seconds, and records the balance reading as tare weight. There is no check for balance drift. This option could cause the ending error to be as great as 20 milligrams.

The STANDARD, LOW MOISTURE and ULTRA-LOW MOISTURE options do check for balance drift caused by temperature changes and offer greater accuracy, but at increased tare times. In these three options, the pan tare algorithm checks to ensure that the balance has drifted less than 0.3mg during a variable TARE TIME (a few seconds to several minutes).

For example, a pan tare using the ULTRA-LOW MOISTURE option checks to ensure that the balance has drifted less than 0.3mg in the last 30 seconds after the tare command was issued to the balance. This requires that the balance be tracked for the initial 30 seconds.

If the drift is excessive at the end of that time, the balance is rechecked every six seconds, and the value is compared against the previous 30 seconds of data until the 0.3mg criteria is met. Depending upon the situation, an ultra-low moisture tare can take as long as three minutes.

The ULTRA-LOW MOISTURE option should be used for samples with a moisture content between 0.005 and 0.2 percent. This option may be used to improve accuracy for samples with moisture content in excess of 0.2 percent but will increase the overall testing time.

When the tare criteria have been successfully met, the balance is re-tared to zero and the unit beeps to indicate that it is ready for the sample to be loaded.

To select a PAN TARE OPTION, move the highlight bar to the desired choice and press **[Select]**. To store the new selection, press **[Esc]**.

⇒ **Sample Tare Option**

There are five possible choices under this menu. The factory default is START WHEN STABLE.

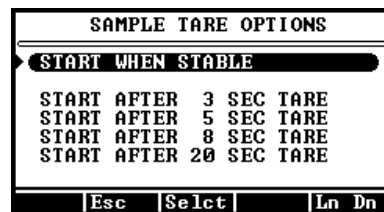

Start When Stable - The balance will start to tare after two seconds. Tare is complete and the test will begin when the balance is stable. The balance is stable when there is less than ± 0.3 mg difference in the weight measured on successive weight readings.

Start after 3 Second Tare: Test starts after a three second wait.

Start after 5 Second Tare: Test starts after a three second wait and five seconds of averaging.

Start after 8 Second Tare: Test starts after a three second delay and eight seconds of averaging.

Start after 20 Second Tare: Test starts after a three second delay and twenty seconds of averaging.

To select a SAMPLE TARE OPTION, move the highlight bar to the desired choice and press **[Select]**. To store the new selection, press **[Esc]**.

⇒ Special Options

Provides the means to tare either a syringe or foil sample carrier.

Syringe Tare: Used when testing materials with high solvent or volatile content. The purpose is to account for the weight loss of material that normally would evaporate during the sample loading process. An external balance with 0.0001-gram (0.1 mg) resolution is used to weigh the syringe before and after loading. The difference in loaded and empty syringe weights is then calculated and entered into the MAX[®] 2000XL at the end of the test as the “NEW START WEIGHT.”

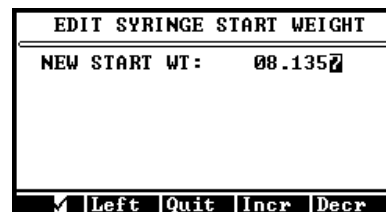

Foil Tare: Used when a sample of sprayed material, such as paint, is to be tested. Up to 25 pieces of foil can be pre-weighed before actual testing begins. The alpha/numeric identity of each foil is stored in memory until it is replaced by other foil tare entries. During a test, the ID of the foil is entered from a menu of stored foils. The weight of the foil is subtracted from the measured weight, giving the true weight of the sprayed sample.

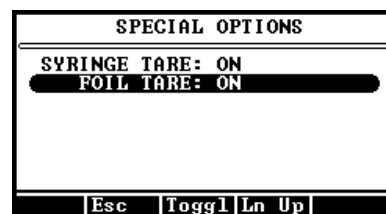

➤ Result Display Options

Selects the final display value of moisture, solids or dry weight.

Test results can be displayed as a percentage of weight lost during the test (Moisture), percentage weight remaining after the test (Solids), or as a dry weight (Dry Wt) basis value. Dry weight basis is the weight loss divided by the weight remaining at the end of the test. Note that the dry weight value ratio can exceed 100%, and often does in applications such as soil and forest fuels analysis.

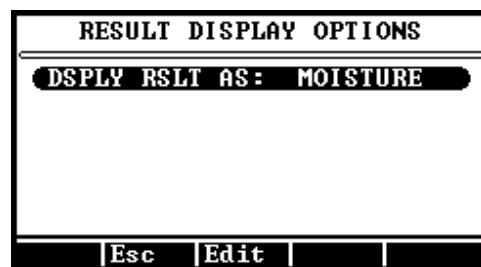

➤ Lift Comp Pct

The value of lift compensation calculated for the instrument.

Programmable lift compensation is a feature found only in Computrac[®] instruments. It is included because of heated air currents in the oven chamber that apply lift to the sample pan. This causes a falsely high apparent weight loss. If not compensated for, this error leads to erroneous moisture values (too high). The amount of lift generated by the hot sample varies from sample to sample, and increases with the test temperature.

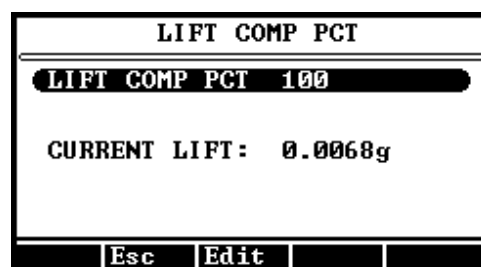

In some cases, the lift is approximately 10 milligrams and is small enough that less sensitive instruments do not provide compensation. Because the MAX[®] 2000XL can sense a weight change as small as 0.1 milligrams, the lift must be compensated for when testing samples that have a total weight change smaller than the lift value.

For example, some plastic resins are controlled to a moisture content of 0.01%, so for a 30-gram sample, the weight change is only 3 milligrams. Similarly, some lyophilized drugs are so valuable that the sample weighs only 150 milligrams. At 2% moisture, the weight change is only 2 milligrams.

The MAX[®] 2000XL automatic lift compensation factor is determined at the factory. Each instrument is characterized for lift produced under standard conditions, and for the way that lift changes for various test temperatures. The factor is called the 100% lift compensation value. Each sample material has a degree of similarity to the maximum lift sample, and this is expressed as a percentage of the maximum lift. This value is entered under LIFT COMP PCT (lift compensation percentage). **Use 100% for all samples unless it is found by experiment that another value is more appropriate.** Contact your AZI technical sales representative at 1-800-528-7411 or 1-602-470-1414 for help on determining the proper value for difficult applications.

➤ **Linked Test Options**

Allows multiple successive memory starts to be run together as one test. Increasing temperatures, rates, times, etc., may be selected to monitor the progress of moisture loss for research and/or control purposes.

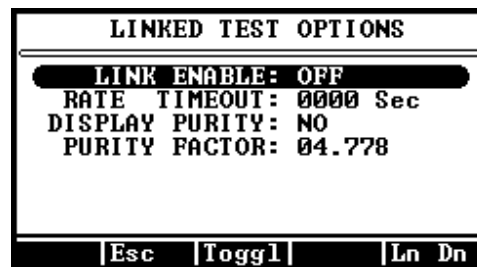

In some materials, such as gypsum powder, moisture occurs in more than one molecular state, usually free water and one or two bound-water states. Free water evaporates from the sample at relatively low temperatures, typically 40 °C to 80 °C. Bound water, however, requires higher temperatures, around 135 °C and others around 240 °C, to break the molecular bonds. To provide operator convenience and to avoid rehydration of the sample in handling, the MAX[®] 2000XL Linked Test Option may be turned on. As the test for free moisture is completed, the next memory start in sequence will be initiated. This subsequent memory start must contain the parameters for the bound water test. The sample integrity will not be compromised between tests since the instrument's lid is not opened.

Link Enable - Although all 245 programmable memory start locations may be linked, there is usually no need to link more than two or three. The linked test will end when a memory start containing Link Enable - OFF is encountered. To run a single memory start, the Linked Test Option must set to OFF.

Rate Timeout - If the Rate Ending Criteria is selected and the sample loses no moisture, the test will never end. To allow the test to end after a reasonable time, the Rate Timeout option may be set to the desired time. Setting the time to "000" disables this option.

Display Purity - Turns the purity calculation on or off. The calculation multiplies the percent moisture by a Purity Factor of a product to provide an indication of impurities in the product sample.

Purity Factor - A number, provided by the user and entered as a parameter for the purity calculation. The default number is 4.778, which is the purity factor for gypsum.

➤ **Reorder Memory Start**

Allows a stored parameter set to be copied from one position and pasted to another position in the list. If you paste a set over an existing set, the existing set is replaced and cannot be recovered, so use this feature with care! To quickly create a new set similar to an old one, use REORDER to copy the old one to a blank location, then use ADD/EDIT to enter the new name and changed values.



➤ **Delete Memory Start**

This command removes a stored set of parameters. Remember to use this carefully as the information cannot be retrieved. The weight and tartrate parameter sets cannot be deleted with this option.

➤ **Print Memory Start**

This command prints the stored parameters. All 247 (000 to 246) of the numbered Memory Start Sets are printed, giving the values of the parameters shown below in the print out example.

COMPUTRAC MAX2000XL MEMORY START REPORT

#	ID	TST	IDL	HST	SSZ	SWN	LFT	MODE	PMDE	RY	STAB	RATE	TIME
000	WEIGHT	105	025	025	8.0	1.0	010	RATE				1.000	
001	TARTRATE	150	100	025	8.0	1.0	170	RATE				0.025	
002	TPO	125	100	025	20.0	2.0	150	RATE				0.005	
003	BROWN	115	050	025	9.0	1.0	150	RATE				0.050	
128		160	025	025	8.0	1.0	100	TIME					0005
129		160	025	025	8.0	1.0	100	TIME					0005
246	CUSTOM	160	025	025	8.0	1.0	100	TIME					0005

Page X of Y

NOTE: Full printout of the Memory Starts will take five pages to print all 247 sets.

The column headings are abbreviations for the following:

- # Identification Number of the Memory Start Set
- ID Identification Name of the Memory Start Set
- TST Programmed Test Temperature
- IDL Programmed Idle Temperature
- HST Programmed HISTART Temperature Parameter
- SSZ Sample Size
- SWN Sample Window
- LFT Programmed Lift
- MODE Mode (Prediction, Rate, or Time) - End Test On Criteria
- PMDE Prediction Mode - (Auto or Manual)
- RY Reliability Percentage - for End Test on Manual Prediction
- STAB Stability - for End Test on Manual Prediction
- RATE Rate of Weight Loss - for End Test on Rate
- TIME Time - for End Test on Time

6.3. STORED DATA (Not available on 21 CFR, Part 11 compliant instruments)

This function is used to work with data stored in the instrument from past moisture determinations. To access this function, go to the Main Menu and select the STORED DATA MENU.



➤ View Stored Data

This function is used to view a list of all stored test results. The list is presented in abbreviated form consisting of the sample name, date and the final result. Pressing **[Selct]** displays the targeted stability, reliability, tares, rate, and lift compensation percentage, if they have been selected in the REPORT ITEMS TO PRINT menu, as detailed on page 46. Moving the selector bar to a particular test and pressing **[Selct]** changes the screen to a display of the entire stored test result.

➤ Analyze Stored Data

To analyze a set of data, select ANALYZE STORED DATA. This function is used to perform mathematical calculations on selected stored test data.

Mean, Standard Deviation, and Coefficient of Variation are calculated using the following formulas. For 21 CFR, Part 11 compliant instruments, results must be recorded by hand or printed out. The calculations are then performed by means of a calculator or computer.

- Mean or average = total of results divided by number of results.
- Standard Deviation = $\sqrt{\frac{\sum(\bar{x} - x)^2}{n - 1}}$
- Coefficient of Variation = Standard Deviation divided by Mean times 100%

Use the arrow keys to select the data items to be included in the analysis, designating the selected items with **[Selct]**. Notice that each selected item is marked with a triangular symbol at the left of the data item. If one has been designated in error, move the selector bar to it and press **[Dslect]** to deselect (and unmark) it. When all desired items are selected, press **[Calc]**.

The screen will immediately display the number of samples, mean, standard deviation, and coefficient of variation of the selected data set. Below is an example of an ANALYZE STORED DATA calculation report. This report can be printed by pressing **[Print]**. To return to the previous menu, press **[Esc]**.

SAMPLES: 005
MEAN (AVG): 23.593%
STD DEV: 0.0569
CV: 00.21%

➤ **Print Stored Data**

Stored data can be printed to a parallel printer attached to the MAX[®] 2000XL. That same data can also be routed to a computer. Note that up to 108 samples can be stored before the oldest is "pushed out" (overwritten). Also note, only data can be retrieved from storage since graphs are not stored. (Graphs can only be printed at the end of the test provided the INCLUDE GRAPH feature is enabled under the REPORT CONTROL OPTIONS, see page 46.) To print stored data, select that option on the STORED DATA MENU and press [Select].

➤ **Delete Stored Data**

This function is used delete individual results and is nonreversible. Normally results are deleted to make management of the data easier and to make room for new tests. If the test results need to be saved, they should first be printed or stored in a computer file. The list consists of the memory start number used, the sample name or lot number, and the final result. Moving the selector bar to a particular test and pressing [Select] will erase the record **so proceed with care!** If the list is empty, the screen will show NO MENU ITEMS.

6.4. CALIBRATION MENU

The calibration menu provides access to instrument calibration and verification routines for the balance and for the heater.

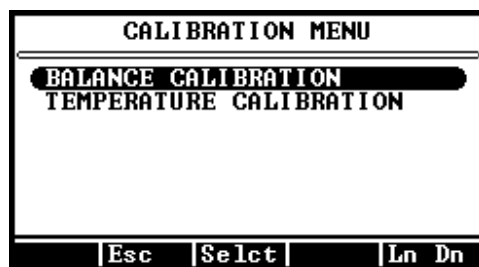

➤ **Balance Calibration Menu**



➤ **Calibrate Balance**

Allows calibration of the balance. The balance should be calibrated immediately after initial setup, whenever the instrument is moved, whenever a problem is suspected or as set forth in your Quality Policy. See Section 5.7 on page 19 for the Balance Calibration instructions.

➤ **Print Balance Cal Report**

Enables the user to print out the Balance Calibration Report via an appropriate attached and configured peripheral. See Section 5.11 **Connecting a Printer** on page 24.

- **Verify Balance Full Range**

Verifies the linearity of the full range of the balance using eight separate verification points. A clean sample pan and a set of eight NIST traceable ASTM class 3 or better 5-gram weights are required for this function, and a set of tweezers is recommended for handling the weights. The instrument temperature must be 40 °C or less to verify the balance. If the instrument has been running at high temperatures, a 2-hour cooldown is recommended before balance verification. Press [**Selct**] to start the balance verification procedure, and follow the on-screen prompts to add and remove weights until the instrument indicates the verification is finished. The results of the balance verification will be displayed and will also print as part of the Balance Calibration Report.

- **Verify Balance Mid Range**

Verifies the linearity of the middle range of the balance using five separate verification points. A clean sample pan and a set of five NIST traceable ASTM class 3 or better 2-gram weights are required for this function, and a set of tweezers is recommended for handling the weights. The instrument temperature must be 40 °C or less to verify the balance. If the instrument has been running at high temperatures, a 2-hour cooldown is recommended before balance verification. Press [**Selct**] to start the balance verification procedure, and follow the on-screen prompts to add and remove weights until the instrument indicates the verification is finished. The results of the balance verification will be displayed and will also print as part of the Balance Calibration Report.

- **Verify Balance Low Range**

Verifies the linearity of the low range of the balance using five separate verification points. A clean sample pan and a set of five NIST traceable ASTM class 3 or better 0.5-gram weights are required for this function, and a set of tweezers is recommended for handling the weights. The instrument temperature must be 40 °C or less to verify the balance. If the instrument has been running at high temperatures, a 2-hour cooldown is recommended before balance verification. Press [**Selct**] to start the balance verification procedure, and follow the on-screen prompts to add and remove weights until the instrument indicates the verification is finished. The results of the balance verification will be displayed and will also print as part of the Balance Calibration Report.

- **Enter Device Data**

Allows entry of the serial number and certification dates of the weight sets used in the balance verification functions above.

- **Setup Balance Cal Prompt**

Allows the user to configure the prompts available to remind you when scheduled calibrations are due. See Section **5.6 Setting Calibration Prompts** on page **18** for more information.

➤ Temperature Calibration

Temperature calibration calibrates the heater over the range 50 °C to 275 °C in 25 °C increments. For optimal performance, the MAX[®] 2000XL temperature calibration should be run in an environment that is free from air currents and general activity (evenings or smaller staffed shifts are best).

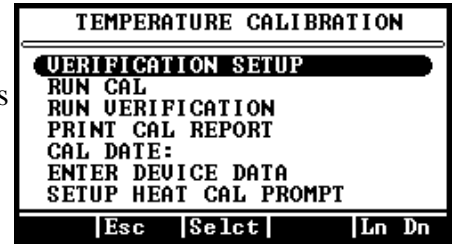

TIP: The temperature calibration and verification take approximately 5 hours. If time is critical, the process can be completed in approximately four hours by running the verification portion manually and opening the lid to cool the unit between the calibration and the verification.

Parts Required

Amt.	AZI Part Number	Description
1	MAX [®] 2000XL	MAX [®] 2000XL Moisture Analyzer
1	Y990-0156	Temperature Calibration Kit 110V with 9 VDC, 100 mA, 3.5 mm male plug, positive tip, DC Adaptor (Y990-0160 is 220V version)
1	Y990-0098	Printer Kit (optional)
1	N/A	Flathead Screwdriver (optional)

- Raise the lid of the MAX[®] 2000XL and turn the instrument power switch to OFF.



Use the supplied tweezers to lift the pan support out of the balance stem. **Be careful - excess force on the balance could result in costly repairs.** Set the pan support aside during the calibration.



- If the outer shroud gasket (AZI P/N 300-0114) is normally used during routine testing (usually with very low moisture samples), ENSURE THAT IT IS REMOVED prior to performing the Temperature Calibration. The gasket will only interfere with the calibration process. See page 13 if necessary to identify parts.
- Place the RTD fixture onto the top of the balance cover so that the disk support sinks into the center hole of the balance cover.
- Turn the RTD fixture so that the wires are positioned at the 4:30 position, when facing the unit from the front, as shown.



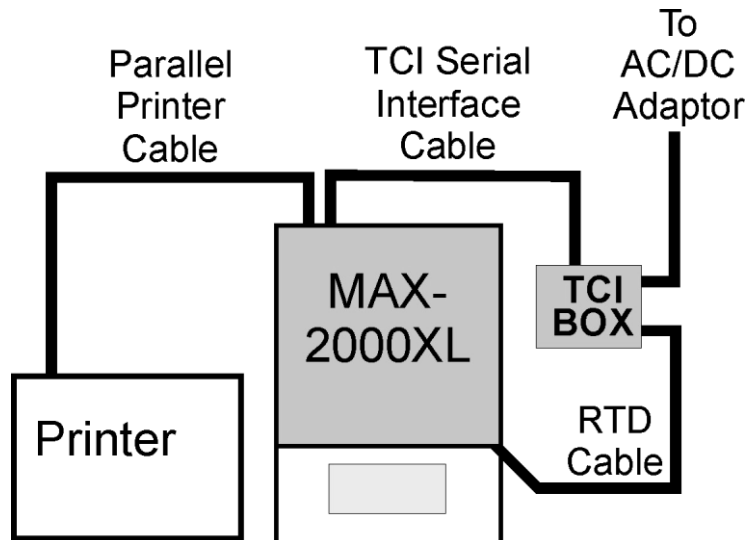

- Plug the probe interface cable into the matching connector on the Temperature Calibration Interface (TCI) box. Plug the RS-232 interface cable into the matching connectors on the cal box and on the back of the MAX[®] 2000XL. Plug the AC adaptor into a 110 VAC outlet.
- Turn the MAX[®] 2000XL ON. From the Main Test Screen, press **[Menu]** to bring up the MAIN MENU. Toggle down (if necessary) so that CALIBRATION MENU is highlighted and press **[Select]**. At the CALIBRATION MENU, toggle down until TEMP CALIBRATION MENU is highlighted and press **[Select]**.
- In the TEMPERATURE CALIBRATION MENU, highlight VERIFICATION SETUP and press **[Select]**.

➤ The purpose of the verification function is to confirm whether the calibration was successful or not at a given set of temperatures. The verification process can be run automatically following the calibration by selecting YES at the AUTO-VERIFY prompt.

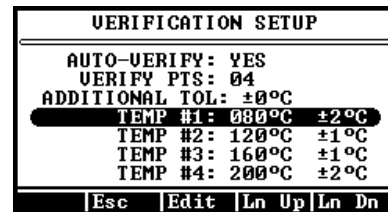

➤ The rest of these instructions assume that the verification is being run automatically. (AUTO-VERIFY: YES)

➤ The standard pass/fail criteria for the verification are as follows:

Temperature Range	Pass/Fail Tolerance
50 °C to 79°C	±3 °C
80 °C to 99°C	±2 °C
100 °C to 199°C	±1 °C
200 °C to 239°C	±2 °C
240 °C to 275°C	±3 °C

- The pass/fail criteria may be changed by selecting and editing the value of ADDITIONAL TOL: to increase the listed values shown. The verification will then give a pass/fail indication at the end of the test based upon the adjusted tolerance. The example at right shows the result of changing the ADDITIONAL TOL: value to 2.

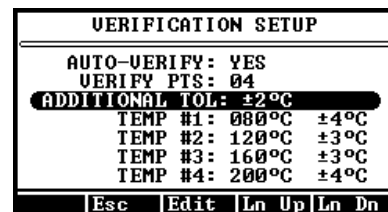

- The tolerance values will change automatically with the temperature entered. The example to the right shows that the tolerance changed from +/-2 to +/-1 when the temperature was changed from 80 °C to 110 °C.

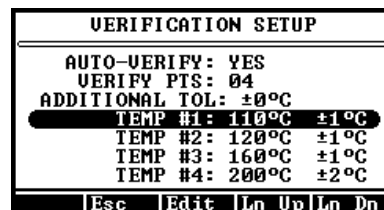

- At the VERIFY PTS prompt, select the number of points to be checked, between 01 and 04. The example to the right shows two points selected with their values edited. To select which temperature(s) will be verified, toggle down to the TEMP # you wish to change and press **[Edit]**. If you do not wish to edit the temperatures, press the **[Esc]** key and move to the next step.

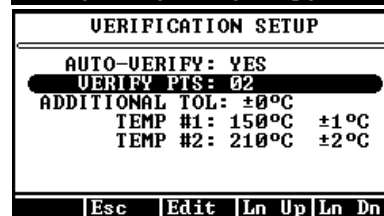

- Using the arrow keys, enter the temperature you wish to verify, between 50 and 275, and press **[Accpt]**. The temperatures selected should be the ones that best represent those used for your product(s). When finished, press **[Esc]** to return to the Temperature Calibration Menu.
- In the TEMP CALIBRATION MENU highlight ENTER DEVICE DATA and press **[Select]**. Using the arrow keys, enter the appropriate serial numbers and calibration date.
 - The interface serial number, probe serial number, and certification date are located on the TCI label (on the black box).
 - The Probe Number located on the RTD fixture should match the probe serial number on the TCI box and the calibration certificate. If it does not, call AZI Customer Service at 1-800-528-7411 or 1-602-470-1414 for assistance.
- When the data has been entered, close the lid.
- Highlight RUN CAL and press **[Select]**. The next screen will ask to ensure that you have the temperature calibration device. If the device is hooked up, press **[Go]**.
- When the verification is complete, the screen will display:
 - The verification temperatures,
 - The error between the MAX[®] 2000XL and the calibration interface, and
 - The pass or fail at each verification point.
- If the unit failed at any given point, save the data and run the calibration again to improve the results. If all the points pass, save the data to store the calibration values.
- If a printer is connected to the MAX[®] 2000XL, highlight PRINT CAL REPORT and press **[Select]** to print out the calibration report.
- Calibration is complete.
 - Turn the instrument off.
 - Disconnect the calibration interface.
 - Carefully remove the RTD fixture from the balance cover.
 - Carefully install the pan support.

6.5. SETUP MENU

The SETUP MENU is used to program the MAX[®] 2000XL with information relevant to all operations. From the SETUP MENU it is possible to set up the Printer, Clock, User ID's and Passwords, Access Codes, Data Screen, and Company Name.

➤ Printer Setup

Identifies the type of printer connected to the instrument, which port is to be used, and if an automatic form feed is desired. If the port option of "Both" is selected the data will be sent to the computer serial port and the parallel printer port.

➤ Report Setup

This menu allows for the program settings related to the final printout of a test. It is in this menu that the printer is enabled and the printout is customized to your needs.

➤ Report Control Options

This screen controls output to the printer and the RS-232 port. It also controls how often the instrument sends data.

- Report Enabled – Select YES to enable reports or NO to disable reports.
- Report Start:
 - START TEST – reporting will begin as soon as the sample tare is complete.
 - 1st PRED – reporting will begin when the first prediction is made.
 - TEST END – reporting is delayed until the test ends and real time data will not be printed during the test.
- Report Interval: Minimum of 00 seconds to the maximum of 99 seconds between reports.
 - If 00 seconds is entered, only the test start and test ending results are output.
- Include Graph: Print the graph (YES or NO). A graphics-capable printer is required if YES is selected. (There is no RS-232 output to the computer)

➤ Report Items to Print

For MAX[®] 2000XL instruments that are not 21 CFR, Part 11 compliant, 108 test results with their test parameters can be stored in memory. These results are available for printing or statistical analysis (mean, standard deviation and coefficient of variation).

- MEM SELCT #: Number of the memory start parameter set for this test.
- SAMPLE NAME: Identification tag for the parameter set used.
- LOT NUMBER: Identification tag for the lot of material to be tested now.
- PRODUCT ID: Identification tag for the product in this lot of tested material. Lot number and product ID are alphanumeric tags entered by the operator to identify a test, or set of tests, for reporting purposes.
- DATE: Date of the test.
- TIME OF DAY: Time of the test.
- FINAL RESULT: Test result value.
- RESULT TYPE: Moisture, solids or dry weight basis.
- TEST MODE: Ending criteria used for this test.
- START WT: Sample basis weight.



- **END WT:** Sample weight at the end of the test.
- **TEST TIME:** Minutes and seconds the test was in progress.
- **START TEMP:** Temperature of the chamber when the test started.
- **TEST TEMP:** Test setpoint temperature.
- **HISTART TEMP:** HiStart temperature setpoint.
- **PAN TARE:** Pan tare setting.
- **SAMPLE TARE:** Sample tare setting.
- **SMPL CENTER:** Nominal load weight for sample.
- **SMPL WINDOW:** Acceptable load weight window for sample.
- **END REL:** Reliability ending criterion value at the end of the test.
- **REL TGT:** Target reliability used for PREDICTION ending criteria.
- **END STAB:** Stability ending criterion value at the end of the test.
- **STAB TGT:** Target stability used for PREDICTION ending criteria.
- **END RATE:** Rate ending criterion value at the end of the test.
- **RATE TGT:** Target rate used for RATE ending criteria.
- **USER NAME:** User ID for the user who ran the test.
- **LIFT PCT:** Programmed Lift Compensation Percentage.
- **FOIL ID:** The name or identification assigned to the foil.
- **FOIL WEIGHT:** The actual tare weight of the foil.
- **PURITY:** The purity of the sample when computed using the purity factor.

➤ **Enter/Edit Company Name**

Allows the report headers to be customized to show the name of the company, test location, or other alphanumeric material.

➤ **Clock Setup**

Used to enter the correct date and time into the instrument's clock system. The internal battery saves the clock value when the power is off. Use this function to change the time at initial setup, when changing for daylight savings time, or when the internal battery is replaced. If the clock resets (or if all memory resets, in fact) whenever the power is off, the internal backup battery may need replacement. If this happens, call AZI Customer Service at 1-800-528-7411 or 1-602-470-1414.

➤ **Data Format Setup**

These three functions do not fit into other menu selection criteria.

⇒ **Ending Criteria Display (EC DISPLAY:)**

This process controls display of the PREDICTED END POINT and the ENDING CRITERIA on the Main Test Screen during the test. Display of these values is useful during parameter development, to aid in selecting the best ending criteria to use for a particular test material. These values serve little purpose, however, during normal operation and may even cause confusion.

⇒ **Lot Number and Product ID (LOT NUMBER:)**

If the LOT NUMBER function is toggled ON in the DATA FORMAT SETUP menu, initializing a material test will bring up a screen labeled EDIT LOT AND I.D. NUMBER. There are ten spaces for the alphanumeric label characters. Each space can be changed with the arrow keys. Pressing [**Incr**] starts at "A" and continues through the alphabet, the symbols, and the numbers. Pressing [**Decr**] starts with the numbers first (9 to 0), followed by the symbols and then the letters. Select the item to be edited with the up and down arrow keys, and press [**Edit**]. Press [**Quit**] when editing is complete. Press [**Accept**] to record the change or [**Cancel**] to leave it unchanged. The instrument will retain and report the additional information.

➤ **Access Key Setup**

Allows entry of access codes to prevent an unauthorized user from accessing any menu where data can be edited, modified or deleted. The use of this option still allows all information menus to be accessed, viewed and printed by any user.

- A master key code permits access to all menus whether they are controlled by individual key codes or not. If the master key code is forgotten, call AZI Customer Service at 1-800-528-7411 or 1-602-470-1414.
- To enter or edit the master key code, highlight EDIT MASTER KEY and press **[Edit]**. Use the arrow keys to enter or edit a master key code of up to eight (8) characters.
- In addition to the master key code, the system allows a calibration key code to be entered so selected users can calibrate the instrument but not have access to other protected menus. To enter or edit this code, highlight the EDIT CAL KEY and press **[Edit]**. Use the arrow keys to enter or edit a parameter key code of up to eight (8) characters.
- To activate the access key codes, highlight ACTIVATE KEYS and toggle the NO to a YES. To deactivate the access key codes, highlight the ACTIVATE KEYS and toggle the YES to a NO.

➤ **Login Setup**

The Login Setup menu is used to turn the Login feature on or off, to set the Admin password, and to enable an administrator to configure up to twenty (20) unique users with user ID's and passwords. When the Login feature is active, tests cannot be run unless a user is logged into the instrument. If the Login feature is active, the Admin password must be entered to access the Login Setup menu.



After entering the Admin password, the administrator will be able to access the Login Setup menu. The initial admin password is eight (8) blanks, and should be changed by the administrator to ensure that access to the instrument is controlled. If the Admin password is forgotten or misplaced, call Arizona Instrument Customer Service for assistance at 1-800-528-7411 or 602-470-1414.

- **Activate Login**

Activate Login is used to toggle the Login feature on and off. With Activate Login highlighted, press **[Toggl]** to activate or deactivate the Login feature. When the Login feature is active, whenever **[START]** is pressed to begin a test, the login screen will appear first. If a user is already logged in, the login screen will display the user ID for the current user, and pressing **[START]** again will begin the test. If a user is not logged in, the login screen will require a user to login before the instrument will proceed to sample testing. The current user can be changed by pressing LGOUT on the login screen and then entering the desired user ID and password.

- **Admin Password**

Admin Password is used to set the Admin password. With Admin Password highlighted, press **[Edit]** to set or modify the Admin Password. See section **5.4 Controls** starting on page **15** for a review of text entry keystrokes and procedures. The initial admin password is eight (8) blanks, and should be changed by the administrator to ensure that access to the instrument is controlled.

- **Edit Users**

Edit Users allows the Admin to create or modify ID's and passwords for users to login into the instrument. If Activate Login is set to YES, a user ID and password must be entered in order to run any tests on the instrument.

Use **[Ln Up]** and **[Ln Dn]** to scroll to the user ID to be created or changed, and press **[Selct]**. The selected user ID can now be set up or modified. Do not use blanks for the user ID or the login feature can be bypassed. If necessary, see section **5.4 Controls** starting on page **15** for a review of text entry keystrokes and procedures.

Each ID and password can be up to eight (8) alphanumeric characters. The user ID of the user who ran a test can be printed along with the other test data, as described in **Report Control Options** on page **46**.

- **TDLTO**

Allows entry of an AZI-supplied password that will override a factory lockout feature. This lockout feature is used on AZI-owned analyzers that are loaned to customers for a short period, so it is not used on customers' equipment.

- **30 Day**

Displays the status of the factory lockout feature. A "NO" indicates that the feature is not active.

- **Balance Mode**

Allows use of the MAX[®] 2000XL as a high-precision balance when not analyzing samples. When in Balance Mode, use **[Tare]** to tare the balance as needed for your application. Use **[Esc]** to exit Balance Mode when finished. The balance in the MAX[®] 2000XL has a range from 150 mg to 40 g, and a resolution of 0.1 mg.

- **Foil Weight Setup**

Allows up to 25 foils that are used during spray paint analysis to be pre-weighed and their weights stored. During the sample test, the stored foil weight is subtracted from the starting weight of the foil and sample.

- Pan tare will first tare the empty sample pan.
- Follow the prompts to open the lid, place a foil on the sample pan, and close the lid.
- After the foil is weighed, the display prompts, "EDIT FOIL ID:" to allow a unique identifying number or name to be given to the foil.
- After entering an ID, the weight of the foil is given. The weight must be saved to be available during sample testing.
- Open the lid and remove the foil to set up the pan tare operation for the next foil to be weighed.
- Press **[GO]** to weigh the next foil or **[Esc]** to return to the SETUP MENU.

7. MEMRY - MEMORY START SELECTIONS

Pressing [**Memry**] will display the Stored Parameter Sets; more commonly called “Memory Starts.” The list looks like the ADD EDIT MEMORY START list and selections are made in the same manner. The difference is that once a selection has been highlighted, the only soft keys that are functional are [**ESC**] and [**START**]. If the Login feature is active, pressing [**START**] will display the Login screen. See **Login** on page 17 for more information. If the Login feature is not active, pressing [**START**] will begin the test.

- Memory Starts are numbered at the left, beginning with 000. A total of 247 different parameter sets can be retained in the system memory. Each has a unique number and a user-entered ID label. Memory Starts 000 Weight Test and 001 Sodium Tartrate are preprogrammed for system verification. These are stored in non-volatile memory and cannot be changed. Memory start 246 is the CUSTOM parameter set. The instrument uses this set when first powered up, if no other memory start parameter set has been programmed and selected. This location is also used to store temporary parameter sets entered after pressing [**Param**] on the Main Test Screen.
- Memory Starts 002 though 245 are programmed by the user through use of menu options to set the parameters into the instrument for specific material that is to be measured on a recurring basis.
- To begin a test using a Memory Start stored parameter set:
 - Press [**Memry**] at the Main Test Screen.
 - Move the selector bar to the desired stored test parameters set with the up and down keys, and press [**START**].
 - If the login feature is active, the login screen will be displayed indicating the user currently logged in to the instrument, if any. If the user is correct, press [**START**] to continue. If the user ID is blank or the wrong user is logged in, enter the appropriate user ID and password to login, and then press [**START**] to begin testing.
 - Unless the LOT NUMBER function is selected, the test will start immediately using the parameters stored in the instrument at that parameter set.

8. GRAPH: DISPLAYING THE MOISTURE TREND PLOT

- At the Main Test Screen, press [**Graph**]. The moisture graph for the current test, or the last moisture test if no test is running, will replace the Main Test Screen. To return to the Main Test Screen, press [**Data**] and then [**Final**].
- The graph displays time, up to 30 minutes, on the X-axis and the result on the Y-axis. The actual moisture (or solids) result (dotted line) and the result predicted (solid line) are displayed on the graph.
- The [**Print**] key acts as a “hot key” and will send the graph to the printer.

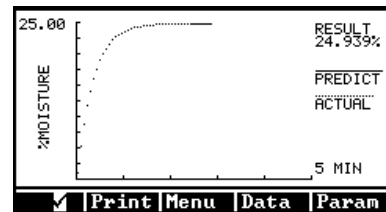

9. PARAM: TEMPORARILY CHANGING TEST PARAMETERS

To develop a new application, a few tests are run with different values for parameters such as temperature and sample size. Ending criteria and sample size are also changed to improve speed and accuracy. To speed this process, the Param function allows immediate alteration of a test parameter and immediate execution of a test from the parameter change screen. This parameter change function is only available for the parameter set stored in Memory Start 246, entitled CUSTOM.

To quickly change a parameter, press [**Param**] at the Main Test Screen. Enter the access code, if needed, and the PARAMETERS MENU START screen will appear. Make the necessary changes to the listed parameters, including a unique sample name to help identify different test runs, and press [**START**] to begin a test with the altered parameter values. If the Login feature is active, the login screen will be displayed and a user must be logged in before any tests can be run.

10. MISCELLANEOUS MESSAGES

10.1. Control Program Version Number

For troubleshooting purposes, AZI Customer Service may need to know the version (or revision) of the control program running in your instrument. To display this information, turn the power off, wait a second, and turn it on again. Observe the front panel. The program version number will be displayed in the lower center portion of the screen for about five seconds.



10.2. Diagnostic Failure Messages

The MAX[®] 2000XL contains extensive diagnostic software, which monitors the performance of the instrument. If a dangerous or abnormal condition is detected, the instrument turns off power to the heater, ends operations, locks the keyboard and displays the following message:

SYSTEM ERROR
(A brief description of the problem)
Software Halted
Power off -> on to reset.

Record the error message and turn the power switch to OFF. Wait ten seconds and turn the power switch back ON. If cycling the power switch does not clear the error, stop using the instrument and call AZI Customer Service at 1-800-528-7411 or 1-602-470-1414.

11. PERFORMANCE ENHANCEMENT

The information presented here is general in nature. Specific information, directed at the chemical, foods, plastics, forest service, and gypsum industries can be found in product related documents.

The Computrac[®] MAX[®] Series loss-on-drying moisture analysis system takes advantage of computer technology to reduce test times and increase precision over standard vacuum oven or convection oven drying procedures. The sample is added to an aluminum sample pan sitting atop an electronic force balance within a test chamber. As the sample heats and loses weight due to moisture evaporation, the balance records that weight loss and transmits the data to the microprocessor. The microprocessor interprets the information and compares the sample's weight loss to a standard drying curve. The final moisture concentration is extrapolated from the curve and results are available within minutes.

A typical drying curve is shown at the right.

- Section (A-B) represents the sample's weight loss as it heats from room to testing temperature.
- Section B-C is linear, representing moisture loss from the interior of each particle of the tested sample.
- Section (C-D) is exponential in nature and represents the final evolution of moisture from within the particle. The point (E) at which no additional weight loss occurs represents the complete evolution of water from the original sample.
- Section (D-E) is the longest and most time-consuming portion of the entire testing process. The time for a sample to reach zero residual moisture in an oven can take from one to possibly 24 hours depending upon the sample, sample preparation, and testing temperature. The MAX[®] 2000XL loss-on-drying system calculates the sample's moisture concentration through mathematical extrapolation from the exponential (C-D) portion of the curve.

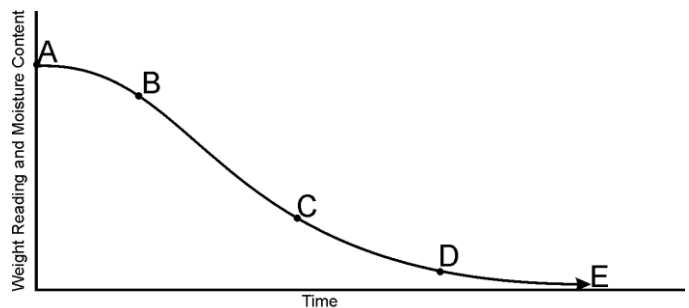

An aluminum pan sits on a pan support coupled to a sensitive electronic force balance. The force balance registers the initial weight of the sample before testing and relays the sample's decreasing weight to the microprocessor for evaluation. Balance readings are averaged to eliminate signal interference or erroneous data.

Within each memory start, test temperatures can be programmed between normal room temperature (25 °C) and 275 °C in either a one or two-step temperature contour. Heating is done through a 700-watt nichrome element, which is located on the underside of the test chamber's lid. An RTD monitors the temperature of the test chamber and sends that information back to the microprocessor. Under the microprocessor's control, the heater element is cycled on and off to bring the test chamber to the programmed level.

During the entire testing process the microprocessor monitors the sample's weight loss. The sample's decreasing weight is compared to the initial sample weight and the calculated moisture concentration will appear on the display. Simultaneously, the microprocessor is predicting a final moisture concentration based upon the sample's rate of weight loss compared to the exponential portion of a standard drying curve. Testing will continue until the predicted moisture concentration agrees within a certain percentage of the actual moisture concentration appearing on the display. The percent agreement between the predicted and the actual moisture concentrations will vary depending upon the system's programming and the moisture level of the sample.

The MAX[®] 2000XL is an extremely flexible instrument. This flexibility means that some time is required to determine the best set of parameters for a particular application. The determination of the proper parameters requires both a series of tests and good laboratory procedure. Call your AZI technical sales representative at 1-800-528-7411 or 1-602-470-1414 for assistance.

11.1. Selection of Test Temperature

If the moisture of the sample material is known, as determined by a reference method (vacuum or air oven), the MAX[®] 2000XL 's temperature can be adjusted until test results correlate with the established moisture concentration. If the moisture is not known, prepare a moisture versus temperature curve to decide the proper test temperature for a particular sample. Sample material is tested at increasing temperature increments of ten degrees each.

The starting temperature is usually the standard or reference method temperature for that particular sample. Results for each increasing temperature will usually rise to a plateau where several increasing temperatures do not change the results significantly. Beyond this plateau results rise dramatically.

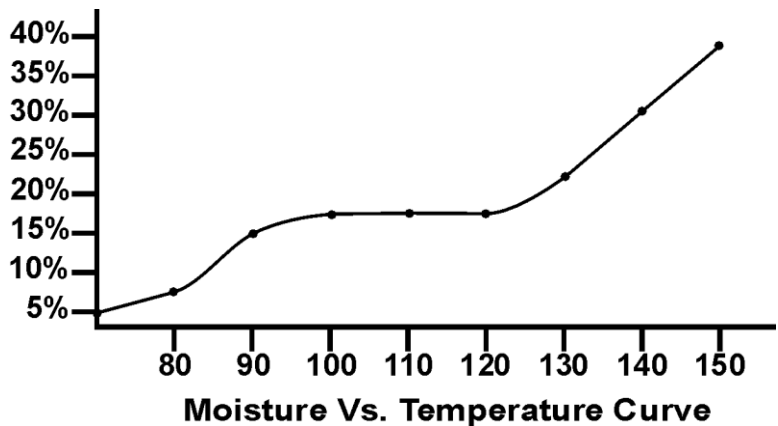

Examination of a sample, tested at these increased temperatures, shows burning or charring.

Results along the plateau usually correlate well with the standard or reference method results. Repeated testing should be done at temperatures in this range. Several tests are performed using the same sample size and test parameters. Results from these repeated tests are tabulated to calculate the mean, or average, and the standard deviation (S.D.). Analysis of the mean and standard deviation, and their comparison with reference method results, determines that the proper test temperature has been used. If mean values do not compare well, or if the standard deviation is too large, test at another temperature along the plateau.

11.2. Selection of Ending Criteria

The decision of which ending criteria to use is application dependent. Best results are typically given with the PREDICTION or RATE, rather than TIME. Experiment with your particular sample to determine which criterion is best for your product.

For END TEST ON PREDICTION, the MAX[®] 2000XL uses a sample dependent test to automatically end a test. The test, called the reliability criterion, is equal to one minus the ratio between the "actual weight loss" at a given moment, and the end point predicted by the microprocessor. The ratio can be set to a value from 00 to 99 depending on the user's desire to balance speed and accuracy. The smaller the number, the sooner each test will end. A value of 99 means the actual weight loss must exceed 99% of the predicted end point.

For END TEST ON RATE, the MAX[®] 2000XL ends the test when the sample weight loss rate has fallen below a preset percentage value. This is useful for samples that do not conform to the standard exponential drying model but will show a consistent moisture rate loss at some point in the process. The parameter may be set for values from 0.001% to 9.999% loss rate.

For END TEST ON TIME, the MAX[®] 2000XL ends the test after a preset time of up to 999 minutes has past. This is sometimes useful for diagnostic and research purposes.

11.3. Preparing Granular and Powdery Samples

The MAX[®] 2000XL system can be used to test a wide range of products from finely ground, low-moisture powders to high-moisture slurries. **For best results, the sample should be of a uniform particle size distributed evenly over the sample pan.** If sample material is collected into a jar or sampling bag, shake the jar or bag to produce a uniform mixture. Liquid samples should also be mixed or shaken to ensure a more homogeneous mixture. Large chunk samples, such as charcoal or cookies, should be crushed or ground to smaller pieces approximately 1/4" or less in diameter.

Some samples, such as dried vegetables, may also need to be ground. The smaller pieces will easily release moisture during testing, leading to shorter test times and more repeatable results. Solid, granular sample material should be shaken onto the pan from a spoon; shaking sample directly from the collection jar will usually deposit only the larger granules, not a representative mixture. Liquid samples or slurries can be spooned or poured onto the sample pan; however, a pipette or sampling straw will collect a more uniform mixture of the sample. All samples should be evenly distributed over the sample pan.

11.4. Preparing and Testing Liquid Samples

Some liquid samples will dry slowly, even at high temperatures. Drops or puddles may form on the pan and dry slowly as the sample concentrates. A skin may form which limits evaporation from the interior. Long test times (greater than 25 minutes) and low percent moisture (or high percent solids values) suggest incomplete drying. Pre-dried glass-fiber filter paper and flat-bottomed pans are recommended to successfully test samples such as these.

- The glass-fiber filter paper, AZI P/N 990-0003, serves as a support for the liquid sample. The sample is absorbed through the paper for more even and rapid evaporation to reduce test times.
- Waffle-bottomed sample pans are **not** recommended for use with filter paper. The liquid sample may soak through the filter paper and collect in puddles in the pan's depressions. Flat-bottom pans are available from AZI as part number 990-0010. Call AZI parts sales at 1-800-528-7411 or 1-602-470-1414 to order.

Occasionally, some samples cannot be absorbed into the filter paper. At the end of the test, examination of the sample pan shows the sample sitting high above the filter paper with a thick crust. The crust may be singed from the heat or even show bubbling where vapor has been trapped beneath the surface. % SOLIDS results will be high or % MOISTURE results will be low. Samples such as these are treated differently: After the sample has been added to the sample pan, remove the pan from the test chamber and place it onto a flat surface. Grasp part of the filter paper (tweezers are suggested) and flip it over so that the sample lies between the pan and the paper. Squash the sample with a flat-bottom glass or jar to a uniform layer. Return the sample pan to the test chamber and close the lid. The upper filter paper surface absorbs moisture from the sample and minimizes bubbling and spattering to produce more accurate, reproducible results.

11.5. Selecting the Optimum Sample Size

Each particular sample will have its own optimum sample size. Best results will be obtained if the sample consists of a single layer of particles, as long as this is sufficient to develop a weight loss of 10 milligrams or more. A rule of thumb is "the lower the moisture, the larger the sample." Low-moisture samples, less than 0.100%, such as chemicals or plastics require larger amounts, 20 to 30 grams of sample. The larger sample size is necessary to provide sufficient weight-loss information to the microprocessor. A larger weight change between the initial and final sample weights will give more accurate, repeatable results. A smaller sample size will give faster tests. Generally, it is best to use a thin layer that just covers the surface of the pan. Very light, or very expensive, test materials may require samples weighing as little as 150 milligrams. Be aware that the standard error will be larger for samples this small, unless the moisture content is sufficient to cause a weight change of 10 milligrams or more for each test. If the first result is too low, increase sample size or raise the temperature. If it is too high, decrease sample size or lower the temperature.

The sample should be added evenly, in a thin layer, across the entire surface of the pan. Once the desired amount has been added, the pan can be removed from the test chamber to evenly distribute the sample. The sample should be distributed over the surface by gentle shaking, tapping, or for very viscous samples, spread with a spoon or knife. Do not spread granular products with a spoon as the particles compress even under gentle pressure, affecting test times and results. An even layer of sample across the pan will reduce test times and increase precision of results.

12. PERFORMANCE VERIFICATION

Periodic checks of the system are recommended to verify proper system operation. These periodic checks will satisfy some quality assurance requirements as specified in your quality assurance/control policy. A log is recommended, either hand written or computer managed, which will record the weight tests, sodium Tartrate tests and retained sample's results. Shifts in results that are out of range can be detected quickly and the appropriate corrections made. If the Login feature is active, a user must be logged in before any testing can be done. See **Login** on page 17 for more information.

12.1. The Weight Test

The weight test, listed on page 21, simulates moisture release with the removal of one of two known weights. This test may be used as part of your control verification program:

- At the interval established by your quality assurance/control program;
- Any time the unit is moved, the power switched off, the instrument is jarred or bumped; and/or
- If there is any concern about the accuracy of the instrument.

12.2. The Precision Weight Test

This is a series of weight tests and is a more critical verification of the instrument's accuracy.

- Perform the steps in the Weight Test (section 5.9) a total of five (5) times.

If this is a 21 CFR, Part 11 compliant instrument, all readings must be recorded by hand; AZI recommends using a printer to capture the values. The calculations must be performed on a calculator since the instrument's storage and analysis functions are disabled.

Mean, Standard Deviation, and Coefficient of Variation are calculated using the following formulas.

- Mean = total of results divided by number of results.
- Standard Deviation = $\sqrt{\frac{\sum(\bar{x} - x)^2}{n - 1}}$
- Coefficient of Variation = Standard Deviation divided by Mean, times 100%

- After all five (5) tests are complete; calculate the mean, standard deviation, and coefficient of variation or press the **[Menu]** key and arrow down to the STORED DATA MENU.
 - PRESS **[Selct]**.
 - Arrow down to highlight ANALYZE STORED DATA and press **[Selct]**.
 - Arrow up or down to select the five (5) weight tests and press **[Calc]**.
- The mean of the indicated weight loss percentage should be 37.500%, +/- .020% for a test using the five and three gram weights.
- If the results obtained from these tests are outside the specified range, call AZI Customer Service at 1-800-528-7411 or 1-602-470-1414 for assistance.

12.3. Sodium Tartrate Test

NOTE: If the outside shroud gasket (AZI p/n 300-0114) is used during routine testing (usually with very low moisture samples), **remove it for this test**. The gasket will interfere with the high moisture test process.

The sodium Tartrate test verifies the heater and force balance operation. Sodium tartrate dihydrate is a chemical with a known moisture concentration that gives up moisture at temperatures greater than 120 °C.

Because of its consistent moisture concentration, it is used as a standard in moisture measurement using oven or titration methods. To obtain consistently reliable results, use a high quality or reagent grade (ACS certified) granular sodium Tartrate. Grind sodium Tartrate that contains lumps or has an uneven consistency. (Lumps in sodium Tartrate usually indicate moisture absorption that will yield inconsistent results.) Sift the sodium Tartrate through a #20 sieve to obtain a more uniform size that will achieve better results. Re-grind the larger chunks and return them to the bottle as well.

The test uses approximately 8 grams of sample and is run at 150 °C. Results should be within a range of ± 0.1 of the assayed value on the label of the chemical. (Sodium Tartrate assayed moistures typically range from 15.61 - 15.71.)

- From the Main Test Screen, press **[Memry]**.
- Highlight “001 ID: TARTRATE.”
- Press **[START]** key.
 - If the Login feature is active, the login screen will be displayed before testing can begin.
- When the “OPEN THE LID” prompt appears on the screen, open the lid and carefully place a new, clean sample pan on the pan support.
- Close the lid and allow the unit to tare.
- When the “OPEN THE LID” prompt appears on the screen again, open the lid and gently and evenly shake sodium tartrate over the surface of the sample pan until the display shows that 7.9 to 8.1 grams of sample are loaded.
- Close the lid and the test will begin.
- Wait for the end of test signal.
- If this is the first test of the day, discard the results of this test for stability reasons.
- Results should be within a range of ± 0.1 of the assayed value on the bottle label.

12.4. Precision Tartrate Test

- Perform five sodium Tartrate tests, as detailed in section 12.3.

If this is a 21 CFR, Part 11 compliant instrument, all readings must be recorded by hand; AZI recommends using a printer to capture the values. The calculations must be performed on a calculator since the instrument's storage and analysis functions are disabled.

- Mean, Standard Deviation, and Coefficient of Variation are calculated using the following formulas.
 - Mean = total of results divided by number of results.
 - Standard Deviation = $\sqrt{\frac{\sum(\bar{x} - x)^2}{n - 1}}$
 - Coefficient of Variation = Standard Deviation divided by Mean times 100%
- Depress **[Esc]** until the MAIN MENU is displayed.
- Calculate the mean, standard deviation, and coefficient of variation or press the down arrow to STORED DATA and press **[Select]**.
- Press the down arrow to ANALYZE STORED DATA and press **[Select]**.
- Select the five Tartrate tests. Press **[Calc]** key.
- Record the results.
- The mean of the sodium Tartrate results should be ± 0.1 of the value on the bottle label.
- If the result is still out of tolerance, the most common causes of such errors are bent or dirty sample pans, or debris that may have fallen into the balance shaft. Switch the unit OFF. Remove the pan support and the balance cover. Carefully clean the instrument (see page 61). Also, clean the heater assembly and check the temperature sensor. If a temperature calibration device (AZI P/N Y990-0156 or -0160) is available, calibrate the system, see page 43.
- Repeat the tartrate test again, using a clean sample pan for each of the five samples, and analyze the results.
- If the mean is still out of tolerance, call AZI customer service at 1-800-528-7411 or 1-602-470-1414 for assistance.

12.5. Retained Samples

The weight test and the sodium tartrate test are usually sufficient to satisfy industry guidelines for quality control in moisture measurement. Some additional checks can be performed using replicate testing of retained samples. Retained samples, when stored under airtight conditions, should maintain moisture levels for long periods. Routine testing of these samples should produce the same results day after day. Retained samples further verify the unit's operation on the customer's own product. If hygroscopic materials are used, the values can change with time and repeated opening of the container.

- Let the system warm up for 20 minutes.
- Set the MAX[®] 2000XL to the optimum test temperature for the retained sample or use the ID Number of a test that has been stored in memory.
- Place a clean aluminum sample pan onto the pan support in the test chamber.
- Close the lid and press **[START]**.
 - If the Login feature is active, the login screen will be displayed before any testing can begin.
- When the OPEN LID display appears, GENTLY add the optimum amount of retained sample evenly across the sample pan.
- Close the lid and allow the test to continue.
- Record the final result in the quality control log.
- The results for the retained sample should fall within the established acceptable range of results for that sample. If results are out of range, repeat the test to verify results and/or perform standard reference testing to certify the percent moisture value.

13. ROUTINE MAINTENANCE

The MAX[®] 2000XL requires routine cleaning to keep the test chamber free of excess sample material. Failure to keep the instrument interior clean reduces its accuracy and repeatability. Sample material collecting in the test chamber prevents free movement of the pan support. Also, sample material collecting on the heater shroud prevents the lid from closing completely, causing erratic moisture results. Material may fall into the system's interior, causing balance problems. Routine cleaning of the test chamber reduces the possibility of problems and repairs, extending the life of the instrument.

13.1. Chamber Interior

The chamber interior should be cleaned when needed to eliminate the buildup of sample material. Switch the main power switch off and use a vacuum line, portable vacuum cleaner, or a small paintbrush to remove debris from the chamber.



A compressed air line or canned air is not recommended since debris migrates into the system's interior and settles in the electronic components.



13.2. Heater Cleaning



Perform a heater cleaning only if a Temperature Calibration Kit, (AZI P/N Y990-0156 or Y990-0160), is available. If not, contact AZI Customer Service at 1-800-528-7411 to arrange for the instrument's return to the factory for cleaning and calibration.



An oven cleaner such as "Easy-Off" should not be used on the aluminum shroud as it is corrosive and will remove the coating and pit the aluminum.



Cleaning frequency will vary depending on the application and frequency of use. We recommend that you establish a periodic cleaning schedule to ensure unit-to-unit correlation and performance. Call AZI Customer Service at 1-800-528-7411 or 1-602-470-1414 if you have any questions.

Testing of some materials may cause a brown discoloration behind the heater and on the inside of the heater shroud. This darkening affects results as heat is absorbed rather than reflected from the heater onto the sample. However, the "browned" condition may be allowed to remain on the heater shroud and heater box if test results can be maintained within an acceptable range.

- Cleaning Materials Needed
 - Cleaning solution, such as 409®, in a spray bottle.
 - Cloth and/or paper towels
 - Small stiff bristle brush, such as a toothbrush or acid brush
 - Cotton swabs or cotton tipped applicators
 - Water for cleaning and wiping shroud and heater after cleaning
 - Small Phillips head screw driver if you elect to remove the shroud
- Turn the unit off and remove the power cord.
- Ensure the unit has cooled down to ambient/room temperature.
- Remove the sample pan.
- Use the supplied tweezers to remove the pan support up and out of the test chamber. **Be careful - excess force on the balance could result in costly repairs.**
- Cover the pan support hole in the bottom of the chamber with masking or other similar tape.
- Carefully mark the RTD with a permanent marker on the inside and outside of the shroud and clamp to mark the relative RTD position in the heater.
- Remove the shroud to provide the maximum cleaning benefit. Remove the four (4) evenly spaced, small screws, located on the outside of the shroud, holding it in place. Carefully slide the RTD out of the shroud. Take care not to pull the RTD wires out of the heater box while removing the shroud.
- Lightly spray the shroud with cleaning solution and allow it to stand for several minutes. Scrub with the stiff bristle brush. Repeat if necessary to remove layers of accumulated buildup. Rinse under warm water and dry.
- Prepare the heater element enclosure by placing paper towels around the elements. Lightly spray the front (face) of the heater box and allow to stand, or alternately spray a damp cloth or paper towel with cleaner and clean the heater box. Use a small brush or cotton swab (Q-Tip) to remove excess buildup. Dry the front of the heater with paper towels or damp a cloth when clean.



Do NOT use a heavy spray of cleaner into the heater and/or shroud area. Excessive moisture could affect wiring and its insulation.



- Allow heater elements and enclosure to dry for at least 15 minutes to ensure that they are completely dry.
- Re-assemble heater and correctly position the RTD using the marks made with the permanent marker.
- Remove the masking tape from the hole in the chamber floor and carefully install the pan support and pan. Run a weight test to verify that the unit is functioning correctly (see page 21). If a temperature calibration interface kit is available, perform a temperature calibration after cleaning.

13.3. Sample Pan Support

The sample pan support may need to be cleaned if high volatile material condenses on it. Turn the unit off and use the supplied tweezers to remove the pan support up out of the test chamber. **Remove the pan support carefully and clean it by wiping with a tissue or paper towel.**

14. TROUBLE MESSAGES

Messages appear on the display screen when certain internal problems occur. You will probably never see one of these messages. However, if one should appear, the message and its meaning are provided in the following table. With each message, a probable cause and a suggested action to take is listed.

BAD EPROM CHECKSUM	The EPROM is continuously checked against a pre-calculated CHECKSUM to insure against failure. This message appears if a discrepancy is detected.
Probable cause:	Bad EPROM chip.
Action:	Replace U4. Call AZI at 1-800-528-7411 or 1-602-470-1414 for assistance.
SRAM	SRAM chip is continuously checked for proper operation during program execution. Message generated if error in SRAM detected.
Probable cause:	Bad SRAM chip.
Action:	Replace U3. Call AZI at 1-800-528-7411 or 1-602-470-1414 for assistance.
HEATER RUNAWAY	Message is generated if the lid is closed and temperature exceeds 290 °C for 3 seconds. It is also generated if the lid is open, and the temperature does not decrease according to an exponential model.
Probable causes:	Failed triac or triac driver (may be both). Excess line noise
Action:	Use power line conditioner or isolated power line. Call AZI at 1-800-528-7411 or 1-602-470-1414 for assistance.
TEMPERATURE CIRCUIT	Message is generated if temperature circuit is not detected.
Probable causes:	Analog-to-Digital (A/D) Converter failure. RTD failure. Bridge circuit failure. MPU failure.
Action:	Check RTD connection to board. Call AZI at 1-800-528-7411 or 1-602-470-1414 for assistance.
A/D TIMEOUT	Message generated if A/D does not clear in 100ms.
Probable causes:	Bad A/D. Bad A/D timing circuit.
Action:	Call AZI at 1-800-528-7411 or 1-602-470-1414 for assistance.
INTERRUPT STARTUP	Something caused the system to crash and reset.
Probable cause:	RAM corruption of some kind.
Action:	Call AZI at 1-800-528-7411 or 1-602-470-1414 for assistance.

15. TROUBLE DIAGNOSIS

SYMPTOM	DIAGNOSIS	REMEDY
Answer always zero (for % moisture results) or answer always 100% (for % solids results)	Pan support height incorrect	Adjust pan support height, see page 13 or call AZI at 1-800-528-7411 or 1-602-470-1414 for assistance
	Temperature too low	Raise temperature, see pages 32 & 54
	No heat	See No Heat symptom later in table
	Sample too small	Increase sample size, see pages 34 & 56
	Lift compensation too large	Reduce lift comp pct, see page 37
Answers vary too much	Test temperature incorrect	Determine temperature/ending criteria to use or call AZI at 1-800-528-7411 or 1-602-470-1414 for assistance
	Ending criteria incorrect	
	Sample size too small	Increase sample size, see pages 34 & 56
	Samples not uniform	Grind sample, see page 55
	Sample particles too large	
Blank display or very hard to see	Contrast controls not set	Adjust contrast, see page 15
	No power	Check power cord connections, see page 14
	Microprocessor failure	Turn unit OFF and back ON. Call AZI at 1-800-528-7411 or 1-602-470-1414 for assistance
	Backlight connector disconnected	Open front panel and reconnect. Call AZI at 1-800-528-7411 or 1-602-470-1414 for assistance
Heat will not turn off	Circuit board failure	Call AZI at 1-800-528-7411 or 1-602-470-1414 for assistance
Clock resets when power is turned off	Internal battery may need replacement.	Contact AZI at 1-800-528-7411 or 602-470-1414.

Moistures too high or solids too low	Temperature set too high	Lower temperature, see pages 32 & 54
	Bent sample pan	Use new pan
	Dirty sample pan	Use new pan
	Debris in balance gaps	Call AZI at 1-800-528-7411 or 1-602-470-1414 for assistance
	Lift compensation too small	Increase lift comp pct, see page 37
	Dirty heater assembly	Clean heater assembly, see page 61
	Ending Criteria incorrect	Determine new ending criteria, see page 33. Call AZI at 1-800-528-7411 or 1-602-470-1414 for assistance
Moistures too low or solids too high	Temperature too low	Increase temperature, see pages 32 & 54
	Sample size too small or too large	Adjust sample size, see pages 34 & 56
	Sample needs spreading	Spread sample evenly, see page 55 and/or 56
	Lift compensation too large	Decrease lift comp pct, see page 37
	Ending Criteria incorrect	Determine new ending criteria, see page 33. Call AZI at 1-800-528-7411 or 1-602-470-1414 for assistance
Moisture never stops increasing	Other volatiles	Try lower temperature, see pages 32 & 54
	Balance drifting	Run drift check, see page 70
Nothing prints on printer	The correct printer was not selected in the Setup menu	See page 24.
Printer stops working	MAX [®] 2000XL turned on while printer was turned off	Turn off both. Turn on printer first, then turn on MAX [®] 2000XL.
No graphical display	Graphics not selected	Press Graph key at Main Test Screen
No heat	Voltage selection wrong	Check power module at rear of instrument, set to correct voltage. See page 14
	Wiring failure in heater circuit	Call AZI at 1-800-528-7411
	Heater failure	Call AZI at 1-800-528-7411

No heat (cont.)	Door sensor failure	Check display for LID OPEN message when open during a test, call AZI at 1-800-528-7411 or 1-602-470-1414 for assistance
	Temperature setpoint too low	Raise temperature above room ambient or standby temperature, see pages 32 & 54
No power to instrument	Power switch off	Check switch position, confirm power cord seating, test circuit with lamp, remove and test fuse, see page 14
	Power cord disconnected	
	Outlet not powered	
	Fuse blown	
No weight reading	Balance not initialized	Turn power off, wait 5 seconds, then turn power on, wait 15 seconds. Call AZI at 1-800-528-7411 or 1-602-470-1414 for assistance
Erratic results	Poor AC ground	Ensure instrument is grounded from case ground to earth ground, see page 14
	Dirt in chamber	Clean unit, see page 61
	Dirt in Pan Support	See page 61 or call AZI at 1-800-528-7411 or 1-602-470-1414 for assistance
	Pan Support height incorrect	Adjust pan support height, see page 13 or call AZI at 1-800-528-7411 or 1-602-470-1414 for assistance
Display erratic	Unit cold (near freezing)	Allow to warm-up
UNDERLOAD when [START] pressed	Sample pan or pan support not in place	Install pan and/or support, [Quit] test and press [START] again, see page 13
Test will not start	Login is active, but no user is logged in.	Log in. See page 17.
Instrument won't tare	Test chamber temperature fluctuates/changes	Allow system to stabilize.
		Check tare options, see page 35
	Dirt in test chamber or under pan support	Clean instrument, see page 61 and following

16. SPECIFICATIONS

These specifications are intended as a guide to proper use of the instrument. Specifications and features will vary with application. AZI product specifications are controlled by ISO-9001 procedures and are established and verified during design. They are not to be construed as test criteria for every application. Refer to AZI document Number 720-0040 for current specifications controlling this instrument. All specifications and features are subject to change without notice. Periodically contact Customer Service, 1-800-528-7411 or 1-602-470-1414, to see if any upgrades are available for your instrument.

FEATURE	SPECIFICATION
Dimensions	235mm H x 300 mm W x 575 mm D (9.5 in H x 12 in W x 24 in D)
Weight	13.9 kg (32 lbs.)
Casework	Per drawing 7200-0244
Power Requirements	110 - 120 volts 50/60 HZ, 1 amp standby, or 8 amps heat on, or 210 - 240 volts 50/60 HZ, 0.5 amp standby, or 4 amps heat on. Power control and fuses at rear of unit
Heating Range	25 °C to 275 °C setpoint in 1 °C increments
Heater Calibration	Menu driven, automatic calibration and verification traceable to NIST. Requires temperature calibration kit (AZI part number Y990-0156 for 110V or Y990-0160 for 220V)
Temperature Control	<ul style="list-style-type: none">• ± 3 °C between 50 and 79 °C• ± 2 °C between 80 and 99 °C• ± 1 °C between 100 and 199 °C• ± 2 °C between 200 and 239 °C• ± 3 °C between 240 and 275 °C
Test Temperatures	User-set to control Idle, Hi-Start, and Test Temperatures through the heating range.
Balance	Built in, automatic operation Stand-alone high precision balance mode available when not testing samples
Sample Size	150 milligrams to 40 grams
Resolution	Moisture - 0.001%, Balance 0.0001 gram
Balance Calibration	Automatic, menu-driven, one-point calibration at 20 grams

FEATURE	SPECIFICATION
Balance Verification	Automatic, menu-driven, multi-point balance linearity verification across three ranges: <u>Low range</u> : Five (5) point verification from 0 to 2.5 grams Pass/Fail criteria: each point within $\pm 0.30\%$ of specified weight <u>Mid range</u> : Five (5) point verification from 0 to 10 grams Pass/Fail criteria: each point within $\pm 0.15\%$ of specified weight <u>Full range</u> : Eight (8) point verification from 0 to 40 grams Pass/Fail criteria: each point within $\pm 0.10\%$ of specified weight
Display	30 character, 9 row LCD with back light; text or graphic test display
Test Display	Continuous text or graphic display of test time, current temperature, programmed test temperature, and current sample weight and calculated weight loss.
Interface	RS-232 (9 pin standard) serial port and bidirectional parallel printer port (25 pin standard)
Moisture Range	0.005% to 100% moisture
Repeatability	$\pm 0.002\%$ standard deviation, depending upon program
Firmware	Menu-driven through LCD display
Memory	Storage of up to 108 test results and up to 245 different test parameters plus 2 quality test programs (weight test and tartrate)
Statistical Calculation	Mean, standard deviation, and coefficient of variation Stored Data features can be disabled for compliance with 21CFR, Part 11
Access Code	Two user-selectable codes, up to eight (8) digits in length; One master code and one calibration code; no limits to access on memory starts; one “universal” code for factory use and override
User Logins	Up to twenty (20) user ID’s and passwords can be defined. When this feature is utilized, a user must be logged in to perform a test. The user ID can also be printed on the test data report.
Results Display	Moisture, solids, or dry weight
Ending Criteria	Predict, both automatic and manual Rate, from 0.001%/minute to 9.999%/minute Time, from 001 to 999 minutes
Programmable Features	Sample name Lot number or product ID Balance and temperature calibration prompts Linked tests for multiple test parameters without opening the lid Syringe and foil tare operation for precise test start weights
Certifications	US and Canadian Underwriters Laboratory (UL) European Communities, CE Arizona Instrument LLC is an ISO 9001 registered company

17. ACCESSORIES & MAINTENANCE PARTS

CONSUMABLES

800-0037	Sodium Tartrate (500 gram bottle)
990-0003	Filter Paper (100 PCS)
990-0008	Waffle Bottom Sample Pans (100 PCS)
990-0010	Flat Bottom Sample Pans (100 PCS)

SPARE PARTS

170-0014	Fan
190-1001	8 Amp Fuse
190-1002	4 Amp Fuse
200-0002	Power Cord - 110V
200-0003	Power Cord - British Standard - 220V
200-0008	Power Cord - Continental Europe - 220V
200-0021	Optical-switch Cable Assembly
200-0026	RTD Cable Assembly
300-0106	Inside Shroud Gasket
300-0114	Outside Shroud Gasket
300-0176-PREP	LCD Module (assembled)
355-0079	Gas Spring
600-0152	Pan Support Assembly (Post and Tray Holder)
690-0003	3g Weight
690-0004	5g Weight
690-0007	20g Weight
690-0012	Tweezers
700-0104	MAX [®] 2000XL v4.36 User's Manual
Y990-0129	Pan Support Post Replacement Kit (Post only)

OPTIONS

Y990-0156	Temperature Calibration Interface Kit with DC Adaptor (110 VAC input, 9 VDC output, 100ma, 3.5mm male plug, positive tip)
Y990-0160	Temperature Calibration Interface Kit (220V version)
6000-1044	Null MODEM Cable
990-0046	Nitrogen Purge Kit
990-0093	Carrying Case
990-0114	H ₂ S Filter Kit
Y990-0070	Communication Software Kit
Y990-0097	Dust Filter Kit
Y990-0098	Printer Kit, Parallel, 110 V
Y990-0105	IQQQPQ Validation Package
Y990-0131	Accessory Kit, MAX [®] 2000XL

18. APPENDIX A - DRIFT TEST

It is possible to check the drift of the balance to determine if instability is occurring and having an effect on the results. This test may be helpful as a troubleshooting tool if instability is suspected. If the Login feature is active, a user must be logged in before any testing can commence.

- Program an empty Memory Start location, or program the [**Param**] key location to the following testing conditions:

Sample Name:	Drift
Test Temperature	200 °C
Ending Criteria	End Test on Time
Time to End	20 minutes
Sample Size	25 grams
Sample Window	6 grams
Tare Options	
Pan Tare Option	Standard
Sample Tare Option	Start After 8 Seconds
Lift Comp Pct	000%

- Use the default parameters for the other program options.
- If the Drift Test parameters were programmed using [**Param**], press the [**START**] key at the opening menu screen.
- If the Drift Test parameters were programmed into a vacant Memory Start location, press the [**Memry**] key to access the stored test programs. Use the up or down keys to highlight the Drift Test location.
- Press [**START**].
 - If the Login feature is active, the login screen will be displayed before testing can begin.
- When the OPEN LID prompt appears on the screen, open the lid and GENTLY place a new, clean sample pan on the pan support.
- Close the lid and allow the unit to tare.
- When the OPEN LID prompt appears on the screen, open the lid and carefully place a 20-gram weight and a much smaller weight, such as 20-milligrams (not normally supplied), onto the sample pan.
- Close the lid.
- After the testing screen is displayed and the temperature reaches 200 °C, gently open the lid and carefully remove the small weight.
- Wait for the end of the test.

- Press [Menu].
- Use the up or down arrow key to highlight the STORED DATA MENU.
- Use the up or down arrow key to select VIEW STORED DATA.
- Use the up or down arrow key to highlight the DRIFT TEST.
- Record the START WT and the END WT.
- The following example shows how to calculate the unit's drift:

Start Wt.	20.0255 g
- End Wt.	-19.9984 g
<hr/>	
Difference	00.0271 g
- Less Removed Wt	-00.0200 g
<hr/>	
Total Drift	00.0071 g

- The total drift value must be 0.000 ± 0.010 grams. Repeat the test several times for precision studies.
- Should the unit fail this test, repeat the test one more time. It is possible that a random air current or other phenomenon caused the unit to fail. If the unit's memory is erased, it will fail a drift test every time. If the second drift test does not pass, call AZI customer service at 1-800-528-7411 or 1-602-470-1414 for assistance.

19. WARRANTY

Arizona Instrument LLC warrants the Computrac[®] MAX[®] 2000XL to be free from defects in materials or workmanship for two years from the date of purchase for those units sold in the USA. All other sales normally carry a one-year warranty. AZI will repair or replace, at its option, products which AZI determines to be defective during the warranty period. All defective parts replaced by AZI become the property of AZI. Replacement parts are warranted for the remaining portion of the effective warranty period. This warranty does not apply to expendable or maintenance items such as pans and pan supports.

The above warranty does not extend to any product which has been subjected to misuse, abuse, neglect, accident, improper application, modifications or service performed by persons other than AZI's own service representatives; power surges or spikes; negligence in use, maintenance, storage, transportation or handling; or an act of God.

If a MAX[®] product is defective in workmanship or materials, the owner's sole remedy shall be repair or replacement of the defective part, or parts, as provided above. Under no circumstances shall AZI be liable in any way to the owner or any user for any damage including, but not limited to, any loss of business or profits or any other direct, indirect, special incidental, or consequential damages, whether or not foreseeable, and whether or not based on breach of warranty, contract, or negligence in connection with the sale of such products. (Some states do not allow the exclusion or limitation of incidental or consequential damages, so the above limitations or exclusions may not apply to you.)

No other warranty is expressed or implied including the warranties of merchantability or fitness for a particular purpose. In no event shall AZI be liable for consequential and/or incidental damages.

The effective warranty begins on the date of purchase by, or lease to, the first end-user (owner). Keep the dated bill of sale, or invoice, for evidence of the effective warranty date when warranty service is requested.

In the event that any questions or problems should arise in the use or application of your Computrac[®] MAX[®] 2000XL unit, call AZI Customer Service or your technical sales representative at 1-800-528-7411 or 1-602-470-1414.

20. MAINTENANCE CONTRACT

Arizona Instrument LLC has a high level of confidence in the reliability of the MAX[®]. Our sophisticated circuits, advanced design and manufacturing techniques result in a unit that performs reliably over an extended period. To demonstrate our confidence, we offer an extended warranty maintenance contract. For a nominal annual charge, AZI will exchange or repair, at the factory, any subassembly or unit, which fails through no fault of the user. This exchange or repair is on a no-charge basis, except for freight. Contact AZI and ask for the Maintenance Contract Sales Representative.

21. TRADEMARK AND COPYRIGHT PROTECTION

Copyright 2006-2009, Arizona Instrument LLC All rights reserved.
Computrac[®], MAX[®], Arizona Instrument, AZI, and the stylized AZI are registered trademarks of Arizona Instrument LLC.
MAX[®] 2000XL is a trademark of Arizona Instrument LLC.
Tygon[®] is a registered trademark of the Norton Company.

ARIZONA INSTRUMENT LLC
COMPUTRAC[®] DIVISION

700-0104-B
COMPUTRAC[®] MAX[®] 2000XL MOISTURE ANALYZER USER'S MANUAL
FIRMWARE VERSION 4.36
MARCH 2009

If you have any questions regarding the operation of this instrument, please call our toll free number, 1-800-528-7411. Internationally, call 1-602-470-1414 or FAX 1-480-804-0656.

Arizona Instrument LLC
3375 N Delaware Street
Chandler, AZ 85225
USA

(602) 470-1414
(800) 528-7411
FAX (480) 804-0656
<http://www.azic.com>
e-mail:
azi@azic.com - General
intl@azic.com - International
support@azic.com - Customer Support